

PRODUKTE + Preise ab  
 alle Preise in Schweizer Franken  
 PRODUCTS + PRICES from  
 all prices in Swiss franc

# 2018



- SPORTGEWEHRE 50M METALLIC** **2** *SPORT RIFLES METALLIC 50M*
- 50M AUFLAGE 50M SYSTEME** **3** *.22SUPPORTED BARREL AND ACTION*
- SPORTGEWEHRE 50M HOLZ** **4** *SPORT RIFLES WOOD 50M*
- KK-SCHÄFTE** **5** *.22 STOCKS*
- STANDARDGEWEHRE HOLZ 300M** **6** *STANDARD RIFLES WOOD 300M*
- STANDARDGEWEHRE METALLIC 300M** **7** *STANDARD RIFLES METALLIC 300M*
- FREIE GEWEHRE 300M FREIGEWHR SYSTEM** **8** *FREE RIFLE 300M FREE RIFLE ACTION*
- SCHÄFTE 300M STANDARD** **9** *STOCKS 300M STANDARD*
- SCHÄFTE 300M LGS, WERKZEUGE** **10** *300M STOCKS AIR RIFLES + TOOLS*
- GRIFFE SCHAFTBACKEN** **11** *GRIPS CHEEKPIECE*
- SCHAFTKAPPEN + HAKEN** **12** *BUTT PLATES+ HOOKS*
- AUSLEGER ZUSATZGEWICHTE** **13** *BUTTPLATE CARRIERS WEIGHTS*
- FLIMMERBAND MAGAZINE, ABZÜGE** **14** *MIRAGE STRAP, MAGAZINE, TIGGER*
- KK-ABZÜGE LAUFHÜLSEN** **15** *.22 TRIGGER TUBES*
- HANDSTOP, STÜTZEN SCHAFTSTATIVE** **16** *HANDSTOP, PALMREST, BI-POD*
- SCHIESSRIEMEN KNEIENDROLLEN** **17** *SHOOTINGBELT KNEELINGROLE*
- DIOPTR UND GEGENLICHTBLENDEN** **18** *REARSIGHTS AND LENSHOODS*
- IRISBLENDEN UND MONOCLE** **19** *SIGHT AND MONOCLE*
- VISIERLINIEN VERLAGERUNGEN** **20** *SIGHT ELEVATION*
- KORNTUNNEL UND WASSERWAAGEN** **21** *FRONTSIGHTS AND BUBBLES*
- RINGKORNE FEST + FILTER** **22** *FRONTSIGHT-RINGS FILTERS*
- VARIABLE RINGKORNE** **23** *VARIABLE FRONTSIGHT RINGS*
- PUTZSTÜCKE + BÜRSTEN** **24** *CLEANING RODS + BRUSHES*
- PUTZMITTEL** **25** *CLEANING AGENTS*
- KOFFER + TASCHEN** **26** *CASES + BAGS*
- GEHÖRSCHUTZ + STATIVE** **27** *EAR PROTECTION + TRIPODS*
- MUNITION + BOXEN** **28** *AMUNITION + BOXES*
- MUNITION 300M + BLEIKER SERVICE** **29** *AMMUNITION 300M + BLEIKER SERVICES*
- HANDSCHUHE SCHUHE, SWEATER** **30** *GLOVES, SHOES SWEATER*
- KOPFBEBECKUNG SCATT** **31** *HEADGEARS SCATT*
- LITERATUR FANARTIKEL** **32** *FANARTICLES BOOKS*



**BLEIKER Freigewehr 50M CHALLENGER MASTER**

- BLEIKER 50M Freigewehrsystem Challenger
- Laufdurchmesser 23,5 mm, Länge 650 mm
- Aluminiumschaft in 6 Farben, Filet schwarz oder weiss,
- 3D Griff, 4 Griffgrößen, Matchabzug 50 - 160 g
- Schaftkappe **Super Grip Match 3**,
- **centra** Diopter SPY mit Korntunnel M 18
- Handstopp, Werkzeug und Serviceheft

**BLEIKER Freigewehr 50M CHALLENGER MASTER**

- BLEIKER 50M free rifle action
- Barrel diameter 23.5 mm, length 650 mm
- Aluminium stock in 6 colours, black or white inlay
- 3D grip, 4 grip sizes, match trigger 50 - 160 g
- **Super Grip Match 3** butt plate
- **centra** SPY rearsight with M 18 front sight tunnel
- Hand stop, tool and user guide



Kal. 22lr 2.103 6850,-



**BLEIKER Freigewehr 50M CHALLENGER BALANCE**

- BLEIKER 50M Freigewehrsystem Challenger
- Laufdurchmesser 23,5 mm, Länge 650 mm
- Aluminiumschaft in 6 Farben, Filet schwarz oder weiss,
- 3D Griff, 4 Griffgrößen, Matchabzug 50 - 160 g
- Schaftkappe **Super Grip Match 3**,
- **centra** Diopter SPY mit Korntunnel M 18
- Handstopp, Werkzeug und Serviceheft

**BLEIKER Freerifle 50M CHALLENGER BALANCE**

- BLEIKER 50M free rifle action
- Barrel diameter 23.5 mm, length 650 mm
- Aluminium stock in 6 colours, black or white inlay
- 3D grip, 4 grip sizes, match trigger 50 - 160 g
- **Super Grip Match 3** butt plate
- **centra** SPY rearsight with M 18 front sight tunnel
- Hand stop, tool and user guide



Kal. 22lr 2.102 6850,-



**BLEIKER Sportgewehr 50M CHALLENGER LADY**

- BLEIKER 50M Sportgewehrsystem, 5.0 - 6.5 kg
- Laufdurchmesser 23,5 mm, Länge 600 mm
- Aluminiumschaft in 6 Farben, Filet schwarz oder weiss,
- 3D Griff, 4 Griffgrößen, Matchabzug 50 - 160 g
- Schaftkappe **Super Grip Match 3**,
- **centra** Diopter SPY mit Korntunnel M 18
- Handstopp, Werkzeug und Serviceheft

**BLEIKER Sportgewehr 50M CHALLENGER LADY**

- BLEIKER 50M sport rifle action, 5.0 - 6.5 kg
- Barrel diameter 23.5 mm, length 600 mm
- Aluminium stock in 6 colours, black or white inlay
- 3D grip, 4 grip sizes, match trigger 50 - 160 g
- **Super Grip Match 3** butt plate
- **centra** SPY rearsight with M 18 front sight tunnel
- Hand stop, tool and user guide



Kal. 22lr 2.104 6850,-





**BLEIKER Sportgewehr 50M AUFLAGE**

- BLEIKER 50M Sportgewehrsystem
- 5 cm längerer Vorderschaft
- Laufdurchmesser 23,5 mm, Länge 650 mm
- Aluminiumschaft, 6 Farben
- 3D Griff, 4 Griffgrößen, Matchabzug **50 - 160 g**
- Schaftkappe **Auflage**
- **centra** Diopter SPY mit Korntunnel M 18
- Auflagekeil, Werkzeug und Serviceheft

**BLEIKER Sportrifle 50M SUPPORTED**

- BLEIKER 50M sport rifle action
- Fore-end stock 5 cm longer
- Barrel diameter 23.5 mm, length 650 mm
- Aluminium stock, 6 colours
- 3D grip, 4 grip sizes, match trigger **50 - 160 g**
- **Supported** butt plate
- **centra** SPY rearsight with M 18 front sight tunnel
- Mounting rail, tool and user guide

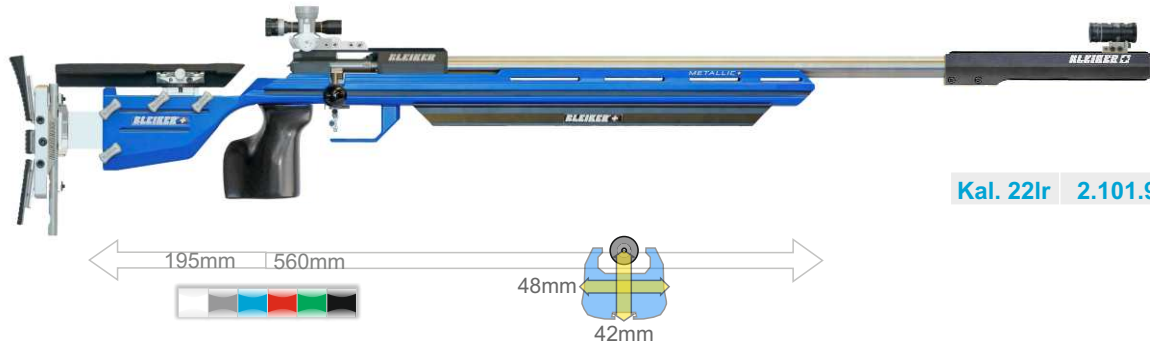
**Kal. 22lr 2.101.9 6950,-**

Griffgröße: <b>S/M/L/XL</b>	Gripsize: <b>S/M/L/XL</b>		<b>freie Wahl / free choice</b>
Schaftfarbe: schwarz, weiss, silber, blau, grün, rot	Stockcolor: black, white, silver, blue, green, red		<b>freie Wahl / free choice</b>
Schaftstreifen: <b>schwarz oder weiß</b>	Stockstripes: <b>black or white</b>		<b>freie Wahl / free choice</b>
Schaftausleger (siehe Seite 13)	Butt plate carriers see page 13)		<b>freie Wahl / free choice</b>
Stabgewicht Vorderschaft <b>130 g</b>	Weight rod fore-end stock <b>130 g</b>		<b>5.523.6 + 75,-</b>
Stabgewicht Vorderschaft <b>250 g</b>	Weight rod fore-end stock <b>250 g</b>		<b>5.523.7 + 95,-</b>
Adapter für Stabgewicht	Adapter for Weight rod fore-end		<b>5.523.8 + 85,-</b>
Spezielle Farbe auf Anfrage	Special Color on request		<b>5.590 + 160,-</b>
Linksausführung	Lefthand stock and system		<b>2.103.1 + 200,-</b>
Tube 217 mm	Tube 217 mm		<b>5.531.4 + 50,-</b>
Tube 290 mm	Tube 290 mm		<b>5.531.5 + 130,-</b>
Handauflage ‚Deluxe‘	Handrest ‚Deluxe‘		<b>5.525 + 285,-</b>
Handauflage ‚SUPPORT‘	Handrest ‚SUPPORT‘		<b>5.527 + 380,-</b>
Munitionstest	Ammunition test		<b>11.212.1 + 80,-</b>
CIP Prüfung	CIP test		<b>11.240 + 70,-</b>

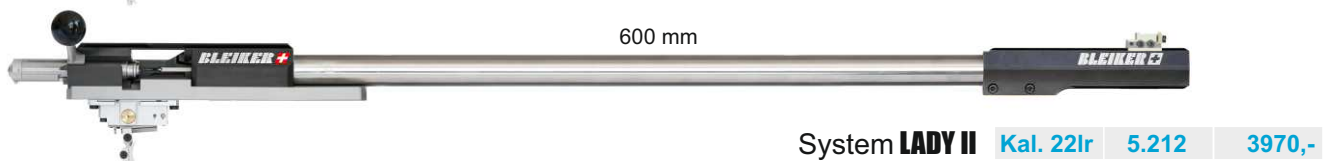
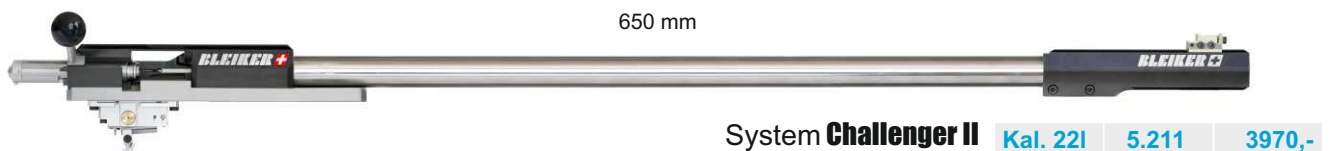
**BLEIKER Sportgewehr-System 50M CHALLENGER II / LADY II**

- Laufdurchmesser 23,5 mm, Länge 650/600 mm
- Hülsenauswerfer ein/ausschaltbar
- Matchabzug **50 - 160 g**
- **Laufhülse 157 mm**, Kornfuss
- Betriebsanleitung und Serviceheft, Koffer

**BLEIKER Sportgewehr 50M CHALLENGER II / LADY II**

- Barrel diameter 23.5 mm, length 650/600 mm
- Cartridge ejector kit on/off
- Match trigger **50 - 160 g**
- **Barreltube 157mm**, Frontsight tunnel base
- user guide, case



Kal. 22lr 2.101 6580,-

**BLEIKER Challenger SPORT**

- BLEIKER 50M Sportgewehrssystem
- Laufdurchmesser 23,5 mm, Länge 650 mm
- Holz, blau/silber oder anthrazit/silber
- 4 Griffgrößen, Matchabzug 50 - 160 g
- Schaftkappe **Super Grip Match 3**,
- **centra** Diopter SPY mit Korntunnel M 18
- Handstopp, Werkzeug und Serviceheft

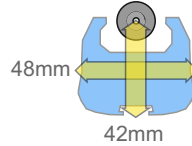

**BLEIKER Challenger SPORT**

- BLEIKER 50M sport rifle action
- Barrel diameter 23.5 mm, length 650 mm
- Wood, painted blue/silver or anthracite/silver
- 4 grip sizes, match trigger 50 - 160 g
- **Super Grip Match 3** butt plate
- **centra** SPY rearsight with M 18 front sight tunnel
- Hand stop, tool and user guide



Kal. 22lr 2.201.5 6680,-

**BLEIKER Challenger WORLDCUP NUSSBAUM**

- BLEIKER 50M Sportgewehrssystem
- Laufdurchmesser 23,5 mm, Länge 650 mm
- Wallnussholz, blau/silber oder anthrazit/silber lackiert
- 4 Griffgrößen, Matchabzug 50 - 160 g
- Schaftkappe **Super Grip Match 3**,
- **centra** Diopter SPY mit Korntunnel M 18
- Handstopp, Werkzeug und Serviceheft

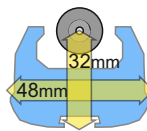

**BLEIKER Challenger WORLDCUP WALNUT**

- BLEIKER 50M sport rifle action
- Barrel diameter 23.5 mm, length 650 mm
- Walnut wood, painted blue/silver or anthracite/silver
- 4 grip sizes, match trigger 50 - 160 g
- **Super Grip Match 3** butt plate
- **centra** SPY rearsight with M 18 front sight tunnel
- Hand stop, tool and user guide

Griffgröße: <b>S/M/L/XL</b>	Gripsize: <b>S/M/L/XL</b>	<b>freie Wahl / free choice</b>
Schaftfarbe: schwarz, weiss, silber, blau, grün, rot	Stockcolor: black, white, silver, blue, green, red	<b>freie Wahl / free choice</b>
Schaftstreifen: <b>schwarz</b> oder <b>weiß</b>	Stockstripes: <b>black</b> or <b>white</b>	<b>freie Wahl / free choice</b>
Schaftausleger (siehe Seite 13)	Butt plate carriers see page 13)	<b>freie Wahl / free choice</b>
Stabgewicht Vorderschaft <b>130 g</b>	Weight rod fore-end stock <b>130 g</b>	<b>5.523.6 + 75,-</b>
Stabgewicht Vorderschaft <b>250 g</b>	Weight rod fore-end stock <b>250 g</b>	<b>5.523.7 + 95,-</b>
Adapter für Stabgewicht	Adapter for Weight rod fore-end	<b>5.523.8 + 85,-</b>
Spezielle Farbe auf Anfrage	Special Color on request	<b>5.590 + 160,-</b>
Linksausführung	Lefthand stock and system	<b>2.103.1 + 200,-</b>
Tube 217 mm	Tube 217 mm	<b>5.531.4 + 50,-</b>
Tube 290 mm	Tube 290 mm	<b>5.531.5 + 130,-</b>
Handauflage ‚Deluxe‘	Handrest ‚Deluxe‘	<b>5.525 + 285,-</b>
Handauflage ‚SUPPORT‘	Handrest ‚SUPPORT‘	<b>5.527 + 380,-</b>
Munitionstest	Ammunition test	<b>11.212.1 + 80,-</b>
CIP Prüfung	CIP test	<b>11.240 + 70,-</b>

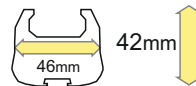

Schaft **SPORT** 46 mm Breite  
Stock **SPORT** 46 mm width

5.500 2230,-

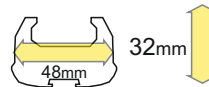

Schaft **WORLDCUP** 48 mm Breite  
Stock **WORLDCUP** 48 mm width

5.502 2230,-

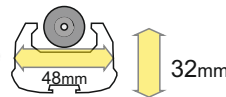

Schaft **MASTER** Metallic  
Stock **MASTER** Metallic

5.503 2550,-

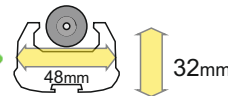
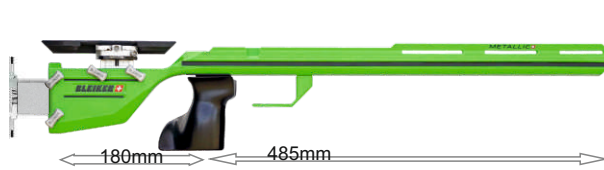

Schaft **BALANCE** Metallic  
Stock **BALANCE** Metallic

5.504 2550,-

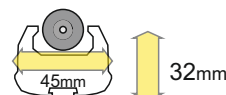

Schaft **LADY** Metallic  
Stock **LADY** Metallic

5.505 2550,-

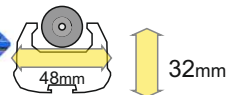

Schaft **AUFLAGE** Metallic  
Stock **SUPPORTED** Metallic

5.506 2830,-

180mm 550mm

Griffgröße: <b>S/M/L/XL</b>	<i>gripsize: S/M/L/XL</i>	<b>freie Wahl / free choice</b>
Schafffarbe: schwarz, weiß, silber, blau, grün, rot	<i>Stockcolor: black, white, silver, blue, green, red</i>	<b>freie Wahl / free choice</b>
Schaftstreifen: <b>schwarz</b> oder <b>weiß</b>	<i>Stockstripes: black</i> or <i>white</i>	<b>freie Wahl / free choice</b>
Spezielle Farbe auf Anfrage	<i>Special Color on request</i>	<b>5.590 + 160,-</b>
Linksschaft	<i>Lefthand stock</i>	<b>2.103.2 + 200,-</b>



**BLEIKER STANDARDGEWEHR 300M ISSF/CISM**

- BLEIKER 300M Standardgewehrssystem, Laufdurchmesser 22 mm, Holzschaft, blau, grau oder Nussbaum, Matchabzug **1500 g**
- Schaftkappe **Super Grip Standard**, **10** Schuss Magazin
- Präzisions Diopter mit Kornfuß und Korntunnel
- Visierlinie zentral, bei Kal. 7.5 auch versetzt
- BLEIKER Handstopp, Flimmerband, Werkzeug, Serviceheft
- Original Schussbild auf 300 Meter

**BLEIKER STANDARD RIFLE 300M ISSF/CISM**

- BLEIKER 300M standard rifle action, barrel diameter 22 mm
- Wooden stock, blue, grey or Walnut, match trigger **1500 g**
- **Super Grip Standard** butt plate, **10**-round magazine
- Precision rearsight with sight dovetail and front sight tunnel
- Aiming line central, Kal. 7.5 offset possible
- BLEIKER hand stop, mirage strap, tool, user guide
- Original target showing shot group at 300 metres



Visierung versetzt (Kal. 7.5) oder zentral  
 Aiming line offset (only Kal. 7.5) or central

Kal. 7.5x55 Swiss	1.111.1	6550,-
Kal. 6 mm BR	1.111.2	6550,-
Kal. 6xC Norma	1.111.3	6550,-
Kal. 6,5x47 Lapua	1.111.4	6550,-
Kal. .308 Win	1.111.5	6550,-

**BLEIKER STANDARDGEWEHR 300M ISSF/CISM-LIEGEND**

- BLEIKER 300M Standardgewehrssystem, Laufdurchmesser 22 mm, Holzschaft, blau, grau oder Nussbaum, Matchabzug **1500 g**
- Schaftkappe **Super Grip Standard**, **8** Schuss Magazin
- Präzisions Diopter mit Kornfuß und Korntunnel
- Visierlinie zentral, bei Kal. 7.5 auch versetzt
- BLEIKER Handstopp, Flimmerband, Werkzeug, Serviceheft
- Original Schussbild auf 300 Meter

**BLEIKER STANDARD RIFLE 300M ISSF/CISM - PRONE**

- BLEIKER 300M standard rifle action, barrel diameter 22 mm
- Wooden stock, blue, grey or Walnut, match trigger **1500 g**
- **Super Grip Standard** butt plate, **8**-round magazine
- Precision rearsight with sight dovetail and front sight tunnel
- Aiming line central, Kal. 7.5 offset possible
- BLEIKER hand stop, mirage strap, tool, user guide
- Original target showing shot group at 300 metres



Visierung versetzt (Kal. 7.5) oder zentral  
 Aiming line offset (only Kal. 7.5) or central

Kal. 7.5x55 Swiss	1.112.1	6550,-
Kal. 6mm BR	1.112.2	6550,-
Kal. 6xC Norma	1.112.3	6550,-
Kal. 6,5x47 Lapua	1.112.4	6550,-
Kal. .308 Win	1.112.5	6550,-

**BLEIKER STANDARDGEWEHR Sport ISSF**

- BLEIKER 300M Standardgewehrssystem, Laufdurchmesser 22 mm, Nussbaum, Matchabzug **1500 g**
- Schaftkappe **Super Grip Standard**, Einzellader
- Präzisions Diopter mit Kornfuß und Korntunnel,
- Visierlinie zentral, bei Kal. 7.5 auch versetzt
- BLEIKER Handstopp, Flimmerband, Werkzeug, Serviceheft
- Original Schussbild auf 300 Meter

**BLEIKER STANDARD RIFLE SPORT ISSF**

- BLEIKER 300M standard rifle action, barrel diameter 22 mm
- Walnut, trigger **1500 g**
- **Super Grip Standard** butt plate, **single shot**
- Precision rearsight with sight dovetail and front sight tunnel,
- Aiming line central, Kal. 7.5 offset possible
- BLEIKER hand stop, mirage strap, tool, user guide
- Original target showing shot group at 300 metres



Visierung versetzt oder zentral  
 Aiming line offset or central

Kal. 7.5x55 Swiss	1.113.1	6650,-
Kal. 6mm BR	1.113.2	6650,-
Kal. 6xC Norma	1.113.3	6650,-
Kal. 6,5x47 Lapua	1.113.4	6650,-
Kal. .308 Win	1.113.5	6650,-

Nussbaumschaft (CISM)	Walnutstock (CISM)	2.101.3	+ 100,-
Linksausführung	Lefthand stock and system	2.103.1	+ 200,-
Laufhülse 157mm, mitte	Tube 157mm, center	5.531.1	+ 250,-
Laufhülse 157mm, versetzt	Tube 157mm, offset	5.532	+ 250,-
CIP Prüfung	CIP test	11.140	+ 70,-

**BLEIKER STANDARDGEWEHR 300M METALLIC ISSF**

- BLEIKER 300M Standard-System, Lauf 22 mm
- Matchabzug **1500 g**
- Aluminiumschaft Metallic, 6 Farben
- **4 Griff-Größen**, vielfach verstellbar
- Schaftkappe **Super Grip Standard**
- bewegliche Schaftbacke, weicht dem Schloss
- Präzisions Diopter mit Kornfuß und Korntunnel
- Visierlinie zentral, bei Kal. 7.5 auch versetzt
- Handstopp, Flimmerband, Werkzeug, Serviceheft
- Original Schussbild auf 300 Meter

**BLEIKER STANDARDRIFLE 300M METALLIC ISSF**

- BLEIKER 300M standard action, barrel 22 mm
- Match trigger **1500 g**
- METALLIC aluminium stock, 6 colours
- **4 grip sizes**, multiple adjustment options
- **Super Grip Standard** butt plate
- Moving cheekpiece, accommodates bolt travel
- Precision rearsight with sight dovetail, front sight tunnel
- Aiming line central, Kal. 7.5 offset possible
- BLEIKER hand stop, mirage strap, tool, user guide
- Original target showing shot group at 300 metres



Kal. 7.5x55 Swiss	1.114.1	6750,-
Kal. 6mm BR	1.114.2	6750,-
Kal. 6xC Norma	1.114.3	6750,-
Kal. 6,5x47 Lapua	1.114.4	6750,-
Kal. .308 Win	1.114.5	6750,-

**BLEIKER STANDARDGEWEHR 300M METALLIC ISSF / CISM**

- BLEIKER 300M Standard-System, Lauf 22 mm
- Matchabzug **1500 g**
- Aluminiumschaft Metallic, 6 Farben
- **4 Griff-Größen**, vielfach verstellbar
- Schaftkappe **Super Grip Standard, 10 Schuss Magazin**
- bewegliche Schaftbacke, weicht dem Schloss
- Präzisions Diopter mit Kornfuß und Korntunnel
- Visierlinie zentral, bei Kal. 7.5 auch versetzt
- BLEIKER Handstopp, Flimmerband, Werkzeug, Serviceheft
- Original Schussbild auf 300 Meter

**BLEIKER STANDARDGEWEHR 300M METALLIC ISSF / CISM**

- BLEIKER 300M standard action, barrel 22 mm
- Match trigger **1500 g**
- METALLIC aluminium stock, 6 colours
- **4 grip-sizes**, multiple adjustment options
- **Super Grip Standard** butt plate, **10-round magazine**
- Moving cheekpiece, accommodates bolt travel
- Precision rearsight with sight dovetail, front sight tunnel
- Aiming line central, Kal. 7.5 offset possible
- BLEIKER hand stop, mirage strap, tool, user guide
- Original target showing shot group at 300 metres



Kal. 7.5x55 Swiss	1.115.1	6950,-
Kal. 6mm BR	1.115.2	6950,-
Kal. 6xC Norma	1.115.3	6950,-
Kal. 6,5x47 Lapua	1.115.4	6950,-
Kal. .308 Win	1.115.5	6950,-

Laufhülse 157mm, mitte	Tube 157mm, center	5.531.1	+ 250,-
Laufhülse 157mm, versetzt	Tube 157mm, offset	5.532	+ 250,-
Linksausführung	Lefthand stock and system	2.103.1	+ 200,-
Spezielle Farbe auf Anfrage	Special Color on request	5.590	+ 160,-
CIP Prüfung 300 Meter	CIP test 300 M	11.140	+ 70,-



**BLEIKER 300M Standardsystem**

- Laufdurchmesser 22 mm
- Länge 600mm
- Standard-Matchabzug **1500 g**
- Flimmerband, Kornfuss
- Betriebsanleitung und Serviceheft
- Visierung zentral oder versetzt

**BLEIKER 300M Standardaction**

- Barrel diameter 22 mm
- length 600 mm
- Standard Match trigger **1500 g**
- Mirage strap, front sight tunnel base
- user guide
- sights central or offset

Kal. 7.5x55 Swiss	5.113.1	3950,-
Kal. 6 mm BR	5.113.2	3950,-
Kal. 6xC Norma	5.113.3	3950,-
Kal. 6,5x47 Lapua	5.113.4	3950,-
Kal. .308 Win	5.113.5	3950,-
links / lefthand	2.103.3	+ 180,-

Mit Magazin und Halterung  
Magazin and fixation **5.115.1 + 330,-**

**BLEIKER FREIGEWehr 300M METALLIC**

- BLEIKER 300M System, Laufdurchmesser 22 mm
- Matchabzug 50 - 160 g, Aluminiumschaft Metallic, 6 Farben
- **4 Griff Größen**, vielfach verstellbar
- Schaftkappe **Super Grip MATCH I**
- bewegliche Schaftbacke, weicht dem Weg des Schlosses
- Präzisions Diopter mit Kornfuß und Korntunnel
- Visierlinie zentral, bei Kal. 7.5 auch versetzt
- Handstopp, Flimmerband, Werkzeug, Serviceheft
- Original Schussbild auf 300 Meter



**BLEIKER FREE RIFLE 300M METALLIC**

- BLEIKER 300M action, barrel diameter 22 mm
- Match trigger 50 - 160 g, Aluminium stock, 6 colours
- **Grip 4 sizes**, multiple adjustment options
- **Super Grip Match 1** butt plate
- Moving cheekpiece, accommodates bolt travel
- Precision rearsight with sight dovetail and front sight tunnel
- Aiming line central, Kal. 7.5 offset possible
- BLEIKER hand stop, mirage strap, tool, user guide
- Original target showing shot group at 300 metres



Kal. 7.5x55 Swiss	1.124.1	7100,-
Kal. 6mm BR	1.124.2	7100,-
Kal. 6xC Norma	1.124.3	7100,-
Kal. 6,5x47 Lapua	1.124.4	7100,-
Kal. .308 Win	1.124.5	7100,-

**BLEIKER FREIGEWehr 300M ISSF Holz**

- BLEIKER 300M Freigewehr-System, Laufdurchmesser 22 mm
- Matchabzug 50 - 160 g, blau, grau oder Nussbaum
- **4 Griff Größen**, vielfach verstellbar, 2 Schaftgewichte je 100g
- Schaftkappe **Super Grip MATCH I**
- Präzisions Diopter mit Kornfuß und Korntunnel
- Visierlinie zentral, bei Kal. 7.5 auch versetzt
- Handstopp, Flimmerband, Werkzeug, Serviceheft
- Original Schussbild auf 300 Meter

**BLEIKER FREE RIFLE 300M METALLIC**

- BLEIKER 300M free rifle action, barrel diameter 22 mm
- Match trigger 50 - 160 g, blue, grey or Walnut
- **4 Grip sizes**, multiple adjustment options, 2 weights 100g
- **Super Grip Match 1** butt plate
- Precision rearsight with sight dovetail and front sight tunnel
- Aiming line central, Kal. 7.5 offset possible
- BLEIKER hand stop, mirage strap, tool, user guide
- Original target showing shot group at 300 metres



Kal. 7.5x55 Swiss	1.122.1	6700,-
Kal. 6mm BR	1.122.2	6700,-
Kal. 6xC Norma	1.122.3	6700,-
Kal. 6,5x47 Lapua	1.122.4	6700,-
Kal. .308 Win	1.122.5	6700,-

**BLEIKER FREIGEWehr 300M Senior**

- 300M Freigewehr-System, Laufdurchmesser 22 oder 23 mm, Nussbaumschaft, Matchabzug **600 - 800g**
- Schaftkappe **Super Grip MATCH I**
- Präzisions Diopter mit Kornfuß und Korntunnel, versetzt
- BLEIKER Handstopp, Flimmerband, Werkzeug, Serviceheft
- Original Schussbild auf 300 Meter

**BLEIKER FREE RIFLE 300M Senior**

- 300M free rifle action, barrel diameter 22 mm
- walnut stock, match trigger **600 - 800g**
- **Super Grip Match 1** butt plate
- Rearsight with sight dovetail and front sight tunnel, offset
- BLEIKER hand stop, mirage strap, tool, user guide
- Original target showing shot group at 300 metres



Kal. 7.5x55 Swiss	1.123	6850,-
-------------------	-------	--------



650 mm

**BLEIKER 300M Freigewehrssystem**

- Laufdurchmesser 22 mm, Länge 650 mm
- Matchabzug **50 - 160g**
- Flimmerband, Kornfuss
- Betriebsanleitung und Serviceheft

**BLEIKER 300M Freerifleaction**

- Barrel diameter 22 mm, length 650 mm
- Match trigger **50 - 160g**
- Mirage strap, front sight tunnel base
- user guide

Kal. 7.5x55 Swiss	5.111.1	3900,-
Kal. 6mm BR	5.111.2	3900,-
Kal. 6xC Norma	5.111.3	3900,-
Kal. 6,5x47 Lapua	5.111.4	3900,-
Kal. .308 Win	5.111.5	3900,-
links / lefthand	2.103.3	+ 180,-





300M ISSF/CISM Standard \*10\*  
300M ISSF/CISM Standard \*10\*

5.512 2100,-

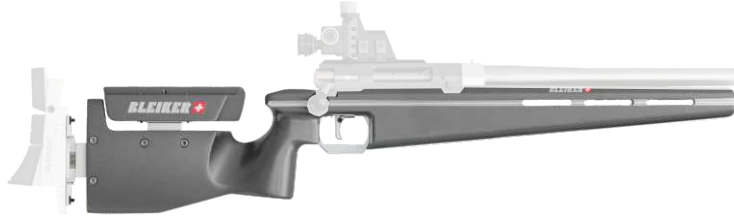

300M ISSF/CISM Standard \*8\*  
300M ISSF/CISM Standard \*8\*

5.513 2100,-



300M ISSF Senior Nussbaum  
300M ISSF Senior Walnut

5.514 2200,-

Erhältlich in blau, grau und natur	Available in blue, anthracite and nature color	<b>freie Wahl / free choice</b>
Ausleger nach Wahl	Buttplate carriers by your choice	<b>freie Wahl / free choice</b>
Linksschaft	Lefthand stock	2.103.2 + 160,-
Weitere Farben (auf Anfrage)	Additional Colours (on demand)	5.590 + 160,-
Nussbaum Schaft	Walnut stock	2.101.3 + 100,-

300M Standard Sport  
300M Standard Sport



5.507 2250,-



300M Freies Gewehr  
300M Free Rifle



5.509 2250,-

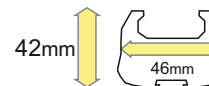

Erhältlich silber/blau und anthrazit, Griff S/M/L/XL	Available silver/blue and anthracite, grip S/M/L/XL	<b>freie Wahl / free choice</b>
Ausleger nach Wahl (siehe Seite 13)	Buttplate carriers by your choice (see page13)	<b>freie Wahl / free choice</b>
Linksausführung	Lefthand stock	2.103.2 + 160,-
Weitere Farben (auf Anfrage)	Additional Colours (on demand)	5.590 + 160,-

300M Nussbaum  
300M Walnut



5.510 2400,-

300M METALLIC ISSF Standard  
inclusiv Adapterplatte für System  
300M METALLIC ISSF Standard  
with connection for action



5.515 2640,-



300M METALLIC CISM Standard  
inclusiv Adapterplatte für System  
300M METALLIC CISM Standard  
with connection for action



5.516 2800,-

300M METALLIC ISSF Freigewehr  
inclusiv Adapterplatte für System  
300M METALLIC ISSF Free Rifle  
with connection for action



5.517 2770,-

Griff S/M/L/XL	Grip S/M/L/XL	freie Wahl free option
Ausleger nach Wahl (siehe Seite 13)	Buttplate carriers by your choice (see page 13)	freie Wahl free option
Linksausführung (Schaft)	Lefthand stock	2.103.2 + 200,-
Weitere Farben (auf Anfrage)	Additional Colours (on demand)	5.590 + 160,-

**Luftgewehre Air rifles**  
Feinwerkbau, Walther, Anschütz, Tesro...  
Aktuelle Modelle, Preis auf Anfrage  
Current models, price on request



4 mm Sechskantstiftschlüssel mit rotem Griff  
4 mm Allen key with red grip



8.610 8,-

Satz Sechskantstiftschlüssel BP 1,5 - 5 mm  
Set of Allen keys, 1.5 - 5 mm



8.621 23,-

**Werkzeuge Tools**



Drehmomentschlüssel Tohnichi  
Torque wrench Tohnichi

8.640 348,-

Einsätze Tohnichi inserts

3 x 28 mm	8.640.1	11,-
4 x 55 mm	8.640.2	17,-
4 x 100 mm	8.640.3	11,-
5 x 55 mm	8.640.4	17,-



centra Tool  
centra Tool

8.630 25,-

Drehmomentschlüssel  
Torque wrench



3 Nm	8.641.1	32,-
4,2 Nm	8.641.2	32,-
5 Nm	8.641.3	32,-

Spannschlüssel 300M  
Spanner 300M



8.643.1 15,-



Handgriff ‚STANDARD‘

Handgriff, 4 Größen, schwenkbar  
Grip, 4 sizes, swiveling



<b>S</b>	5.411.1	295,-
<b>M</b>	5.412.1	295,-
<b>L</b>	5.413.1	295,-
<b>XL</b>	5.414.1	295,-

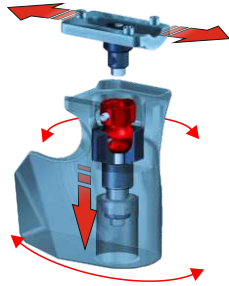

Handgriff ‚CIRCULUS 3D‘ für **KK SPORT / WORLDCUP / METALLIC / LADY**

Griff, 4 Größen, kugelgelagert  
Grip, 4 sizes, ball bearing mounted



<b>S</b>	5.415	375,-
<b>M</b>	5.416	375,-
<b>L</b>	5.417	375,-
<b>XL</b>	5.418	375,-

Links-Griffe mit „L“ nach der Bestellnummer ordern  
Order left-hand grips with „L“ after item number ( 5.411.1. L )

Schaftbacke für **SPORTSCHAFT 300M**  
mit Aluminiumträger  
Cheekpiece for **SPORTSTOCK 300M**  
with aluminium carrier



Visierlinie versetzt  
Aiming line offset

<b>5.421.1</b>	220,-
----------------	-------

Schaftbacke einzeln Cheekpiece separat



<b>5.421.2</b>	125,-
----------------	-------

Schaftbacke für **SPORTSCHAFT 300M**  
mit Aluminiumträger  
Cheekpiece for **SPORTSTOCK 300M**  
with aluminium carrier



Visierlinie zentral  
Aiming line center

<b>5.422.1</b>	220,-
----------------	-------

Schaftbacke einzeln Cheekpiece separat



<b>5.422.2</b>	125,-
----------------	-------

Schaftbacke für **SPORTSCHAFT 300M**  
mit Aluminiumträger, bewegliche Backe für  
Ladevorgang  
Cheekpiece for **SPORTSTOCK 300M**  
with aluminium carrier, moving, accommodates  
bolt travel



<b>5.423</b>	270,-
--------------	-------

Schaftbacke **KK SPORT, WORLDCUP** mit Feinverstellung  
Cheek piece **KK SPORT, WORLDCUP** with fine adjustment



<b>5.431.1</b>	285,-
----------------	-------

Schaftbacke einzeln Cheekpiece separat



<b>5.431.2</b>	115,-
----------------	-------

Schaftbacke **KK SPORT, WORLDCUP** mit Feinverstellung  
ohne Träger

Cheek piece **KK SPORT, WORLDCUP** with fine adjustment,  
without carrier



<b>5.431.3</b>	225,-
----------------	-------

Schaftbacke **PERFECT** für alle **KK Metallic**,  
mit Feinverstellung, jetzt auch diagonal, komplett

Cheek piece **PERFECT** for all **.22 Metallic**,  
with fine adjustment, now too diagonal, complete



<b>5.441.1</b>	380,-
----------------	-------

Mechanik **PERFECT** ohne Kunststoffbacke  
Mechanics **PERFECT** without plastic-cheek



<b>5.441.2</b>	325,-
----------------	-------

Schaftbacke aus Kunststoff, einzeln  
Cheekpiece from plastic, separat



<b>5.441.3</b>	115,-
----------------	-------





Schaftkappe **SUPER GRIP STANDARD**  
Butt plate **SUPER GRIP STANDARD**

- Schaftkappe für Standardgewehr 300M
- dickes, dämpfendes Gummiprofil
- Höhenverstellung mit Skala
- Flügel verstellbar

- Butt plate for Standard rifle 300M*
- thick, soothing profile rubber
  - Height-adjustable with scale
  - Turnable wing



**5.311**    **320,-**

Schaftkappe **SUPER GRIP MATCH 1**  
Butt plate **SUPER GRIP MATCH 1**

- Schaftkappe für KK und 300M Freigewehr
- Gummiprofil und Haken (10cm)
- Höhenverstellung mit Skala
- Flügel verstellbar

- Butt plate for Standard rifle 300M*
- thick, soothing profile rubber
  - Height-adjustable with scale
  - Turnable wing



**5.320**    **460,-**

Schaftkappe **SUPER GRIP MATCH 3**  
Butt plate **SUPER GRIP MATCH 3**

- Das Top Modell für KK und 300M Freigewehr
- Drei bewegliche Elemente und 3-D Haken
- Rutschfestes Spezial-Profil
- Ohne Haken auch für LG

- Top Butt plate for .22 and 300M Free rifle*
- Three free moving elements and 3D hook
  - Special rubber profile
  - Without hook perfect for air-rifle



**5.326**    **550,-**

Schaftkappe **SUPER GRIP MATCH 3 Auflage**  
- ohne Haken, flacher unterer Flügel

- Butt plate SUPER GRIP MATCH 3 SUPPORTED*
- without hook, flat lower wing



**5.327**    **380,-**

**Flügel für SUPER GRIP MATCH 3 Auflage**  
- extra breit, extra lang

- WING for Butt plate SUPER GRIP MATCH 3*
- extra long, extra wide



**5.326.1**    **45,-**

**Haken SUPER GRIP Match 3 / Standard**  
*Hook for SUPER GRIP Match 3 / STANDARD*



**5.343**    **170,-**

**Zusatzelement A für Haken**  
*Additional element A for hook*



**5.344**    **85,-**

**Adapter B für Haken**  
*Adapter B for hook*



**5.345**    **23,-**

Schaftkappe **MEC Free Position II**

- Der Klassiker, jetzt mit Edelstahlfixierungen
- Optimaler Kontakt, schlanke Bauart, ohne Haken auch für LG
- Elemente im Anschlag verstellbar

*Butt plate MEC free position II*

- For sport- and free rifle; without hook for air rifle
- Fixations now from stainless steel, easy to adjust in position
- Perfect contact and extra slim shape

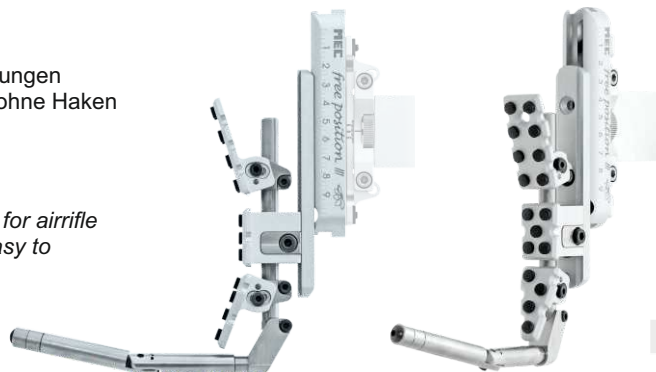

**5.350**    **379,-**



**Ausleger** für alle Schaftkappen  
 - in drei Höhen  
 (für stehend, kniend und liegend)  
 - und in je drei Längen

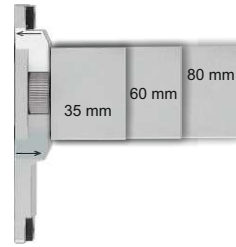
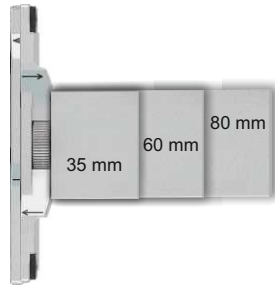

35mm	std	5.331.1	140,-
60mm	std	5.331.2	140,-
80mm	std	5.331.3	140,-

35mm	knd	5.332.1	140,-
60mm	knd	5.332.2	140,-
80mm	knd	5.332.3	140,-

35mm	li/pr	5.333.1	140,-
60mm	li/pr	5.333.2	140,-
80mm	li/pr	5.333.3	140,-

**Carrier** for all hooks  
 - 3 heights  
 (standing, kneeling, prone)  
 - 3 lengths, 35, 60 and 85 mm

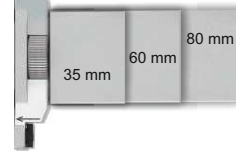

**Ausleger** mit Neigungsmechanik  
 - erlaubt die Drehung der Schaftkappe  
 - in drei Längen

**Carrier** for tilting motion  
 - in 3 length

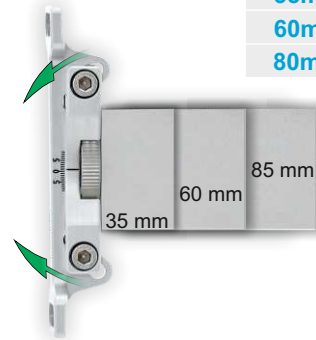
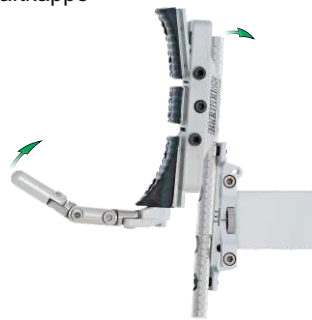

35mm	li/pr	5.342.1	185,-
60mm	li/pr	5.342.2	185,-
80mm	li/pr	5.342.3	185,-

**Zusatzgewicht** für Ausleger, 100 g  
**Additional weight** for carrier, 100 g



5.335	60,-
-------	------



**Nutenstein** für Ausleger  
**T-nut** for carrier



5.346	4,-
-------	-----

**Zusatzgewicht** für Profilschiene, 150g + 50 g  
**Additional weight** profile rail, 150g + 50 g



5.523.4	92,-
---------	------

**Zusatzgewicht** 50 g  
**Additional weight** 50 g



5.523.5	22,-
---------	------

**Zusatzgewicht** Metallic-Schäfte innen, 130 g oder 250 g  
**Additional weight** Metallic stock, 130 g or 250 g



130 g	5.523.6	75,-
250 g	5.523.7	95,-

**Adapter** für Zusatzgewicht Metallic-Schäfte innen  
**Adapter** for Additional weight Metallic stock



250 g	5.523.8	85,-
-------	---------	------

**Zusatzgewicht** für Laufhülse, 50 g  
**Additional weight** tube, 50 g



50 g	5.523.8	29,-
------	---------	------

**Schaftgewicht** 100 g  
**Stock weight** 100 g



100 g	5.523.1	20,-
-------	---------	------



Flimmerband schwarz, ohne Aufdruck  
*Mirage strap black, no print*

Flimmerband schwarz, „BLEIKER“ Aufdruck  
*Mirage strap black, „BLEIKER“ print*

Flimmerband lang, schwarz, ohne Aufdruck  
*Mirage strap long black, no print*

Flimmerband lang, schwarz, „BLEIKER“ Aufdruck  
*Mirage strap long black, „BLEIKER“ print*

Haken für Flimmerband  
*Hook for Mirage strap*



5.141	38,-
5.142	45,-
5.143	38,-
5.144	45,-
5.145	9,-

Magazin 7.5 x 55 10 Schuss

Magazin 7.5 x 55 8 Schuss

Magazin 6 mm BR

Magazin 6XC Norma

Magazin 6.5 x 47 Lapua

*Magazine 7.5 x 55 10 rounds*

*Magazine 7.5 x 55 8 rounds*

*Magazine 6 mm BR*

*Magazine 6XC Norma*

*Magazine 6.5 x 47 Lapua*



Magazineinsatz 7.5 x 55 10 Schuss

Magazineinsatz 7.5 x 55 8 Schuss

*Magazine inset 7.5 x 55 10 rounds*

*Magazine inset 7.5 x 55 8 rounds*

**Blindboden zu System**

**Inset for action**

5.131	200,-
5.131.2	200,-
5.132	200,-
5.133	200,-
5.134	200,-
5.135	95,-
5.135.2	95,-
14.454	38,-

ABZUG 300M Standard, 1500g, mit Zunge  
*TRIGGER 300M Standard, 1500g with tongue*

ABZUG 300M Senior, 600g, mit Zunge  
*TRIGGER 300M Senior, 600g with tongue*

ABZUG 300M MATCH, 50 - 160 g, mit Zunge  
*TRIGGER 300M MATCH, 50 - 160g with tongue*



5.121	550,-
5.122	550,-
5.123	650,-

ABZUGSZUNGE 300M Standard, normal  
*TRIGGER TONGUE 300M Standard, normal size*

ABZUGSZUNGE 300M Standard, lang  
*TRIGGER TONGUE 300M Standard, long*

ABZUGSZUNGE 300M Standard, gerundet  
*TRIGGER TONGUE 300M Standard, rounded*

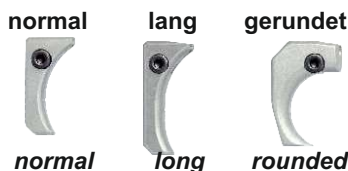

5.121.5	77,-
5.121.6	77,-
5.121.7	77,-

ABZUGSZUNGE 300M Freigewehr ALU  
*TRIGGER TONGUE 300M Free Rifle ALU*



5.123.5	85,-
---------	------

ABZUGSZUNGE 300M Freigewehr MEC TRIGGER II  
*TRIGGER TONGUE 300M Free Rifle MEC TRIGGER II*



5.123.6	88,-
---------	------

LAUFHÜLSE 157 mm zentral  
*TUBE 157 mm center*



5.531.1	250,-
---------	-------

LAUFHÜLSE 157 mm versetzt  
*TUBE 157 mm offset*



5.532	250,-
-------	-------



Klemmhalter zentral  
*Clamp mounting center*



5.530	90,-
-------	------

Klemmhalter versetzt  
*Clamp mounting offset*



5.533.2	90,-
---------	------



**KK Matchabzug**, 50 - 160 g, mit Alu-Zunge, verschleißfreie Mechanik, neu mit Kugellager

**.22 Matchtrigger**, 50 - 160 g with Alu-tongue, new developed ball bearing, cleaner action



5.214 650,-

ABZUGSZUNGE **STARTLINE**  
TRIGGERTONGUE **STARTLINE**

ABZUGSZUNGE **ALU**  
TRIGGERTONGUE **ALU**

ABZUGSZUNGE **MEC TRIGGER II**  
TRIGGERTONGUE **MEC TRIGGER II**



5.123.4 48,-

5.123.5 85,-

5.123.6 88,-

**KK-Verschluss**, für Challenger, komplett  
**.22 Action**, for Challenger, complete



2.215 575,-

**Schloss Aufbewahrung**, für BLEIKER KK-Verschluss  
**Bolt Protection**, for BLEIKER gun lock



links  
left

8.432 69,-

8.432.1 69,-

**KK-Hülseauswerfer**, für Challenger-System, mit Ladebrücke, ein- und ausschaltbar  
**sleeve ejector**, for Challenger, complete with loading rail, power on and off



5.213.2 190,-

**KK - LAUFHÜLSE 157 mm**  
**.22 TUBE 157 mm**



5.531.1 250,-

**KK - LAUFHÜLSE 217 mm**  
**.22 TUBE 217 mm**



5.531.2 300,-

**KK - LAUFHÜLSE 290 mm**  
**.22 TUBE 290 mm**



5.531.3 380,-

**Clamp mounting tube center**



5.530 90,-

**Diopterschiene KK zentral**  
**Mounting rail .22 center**



5.535 74,-





**HANDSTOP „BLEIKER-Basic“ mit Riemenbügel**  
*HANDSTOP „BLEIKER-Basic“ with sling ring*



**8.530 75,-**

**HANDSTOP „BLEIKER-Large“ mit Riemenbügel**  
*HANDSTOP „BLEIKER-Basic“ with sling ring*



**8.531 85,-**

**HANDSTOP MEC-centra, mit Riemenbügel**  
*HANDSTOP MEC-centra with sling ring*



**8.521 125,-**

**HANDSTOP STARTLINE MEC-centra, mit Riemenbügel**  
*HANDSTOP STARTLINE MEC-centra with sling ring*



**8.522 87,-**

**HANDSTOP Anschütz 4751, mit Riemenbügel**  
*HANDSTOP Anschütz 4751, with sling ring*



**8.512 115,-**

**HANDSTOP Anschütz 4752, mit Riemenbügel**  
*HANDSTOP Anschütz 4752, with sling ring*



**8.513 122,-**

**Riemenbügel BLEIKER**  
*SLING RING BLEIKER*



**8.530.2 29,-**

**ZWEIBEINSTÜTZE MEC-centra, Klappfüße, rutschfest**  
*BI-POD MEC-centra, folding legs, anti slip rubber feet*



**8.422 76,-**

**ZWEIBEINSTÜTZE „Freesport“**  
*BI-POD „Freesport“*



**8.422.1 85,-**

**HANDSTÜTZE MEC-centra, vielfältig einstellbar**  
*PALMREST MEC-centra, adjustable in all axis*



**8.422.2 295,-**

**HANDSTÜTZE DELUXE,**  
Höhe und Winkel einstellbar  
*PALMREST DELUXE,*  
*adjustable in all axis*

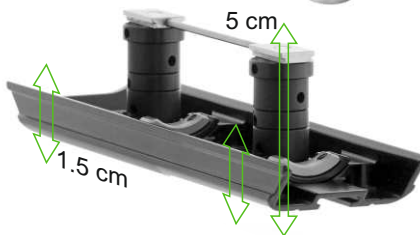

**5.525 285,-**

**Zwischenstück 5 mm zur Handstütze**  
*Interface 5 mm for Palrest*



**5.225.1 11,-**

**Zwischenstück 10 mm zur Handstütze**  
*Interface 10 mm for Palrest*



**5.225.2 13,-**

**HANDSTÜTZE Standard BLEIKER für Sportschaft 300M**  
*PALMREST tandard, BLEIKER,*



**5.524 1305,-**

**SUPPORTED BLEIKER für Auflageschaft**  
*SUPPORTED BLEIKER, 50m Supported stock*



**5.527 380,-**



**SCHIESSRIEMEN „TRUTTMAN TR“  
SHOOTINGBELT „TRUTTMANN TR“**



8.111 110,-

**SCHIESSRIEMEN „TRUTTMAN TR“ mit Feinverstellung  
SHOOTINGBELT „TRUTTMANN TR“ with fine adjustment**



8.112 155,-

**SCHIESSRIEMEN „SWISS-TOP“ mit Seil  
SHOOTINGBELT „SWISS-TOP“ with rope**

8.121.1 175,-

**SCHIESSRIEMEN „SWISS-TOP“ ohne Seil  
SHOOTINGBELT „SWISS-TOP“ without rope**



8.121.2 175,-

**SCHIESSRIEMEN „SWISS-TOP“ mit Seil, schmal  
SHOOTINGBELT „SWISS-TOP“ with rope, narrow**

8.121.3 175,-

**SCHIESSRIEMEN „SWISS-TOP“ ohne Seil, schmal  
SHOOTINGBELT „SWISS-TOP“ without rope, narrow**



8.121.4 175,-

**Seil zum SCHIESSRIEMEN „SWISS-TOP“  
ROPE for SHOOTINGBELT „SWISS-TOP“**

8.122 12,-

**SCHIESSRIEMEN „SWISS-TOP“ Modell 2010  
SHOOTINGBELT „SWISS-TOP“ Modell 2010**



8.123 175,-

**SCHIESSRIEMEN „SWISS-TOP“ Modell 2010, blau  
SHOOTINGBELT „SWISS-TOP“ Modell 2010, blue**

8.123 175,-

**SCHIESSRIEMEN „LOGIC BELT“ AKAH  
SHOOTINGBELT „LOGIC BELT“ AKAH**



8.131 150,-

**Riemenhalter zum SCHIESSRIEMEN „LOGIC BELT“ AKAH  
Connection for SHOOTINGBELT „LOGIC BELT“ AKAH**



8.132 24,-

**SCHIESSRIEMEN „Gehmann“ Modell 436  
SHOOTINGBELT „LOGIC BELT“ AKAH**



8.133 70,-

**SCHIESSRIEMEN „Thune“  
SHOOTINGBELT „Thune“**



8.134 86,-

**SCHIESSRIEMEN „MEC + centra“ SLING  
SHOOTINGBELT „MEC + centra“ SLING**



8.137 199,-

**SCHIESSRIEMEN „MEC + centra“ SLING, Leder  
SHOOTINGBELT „MEC + centra“ SLING, leather**



8.138 219,-

**Kniendrolle „TRUTTMAN Leder“ Ø120 mm, mit Granulat  
Kneelingrole „TRUTTMANN leather“ Ø120 mm, with pellets**



8.211 65,-

**Kniendrolle „TRUTTMAN Leder“ Ø160 mm, mit Granulat  
Kneelingrole „TRUTTMANN leather“ Ø160 mm, with pellets**

8.212 65,-



**Kork für Rolle Cork for kneelingrole**

8.213.1 15,-

**Granulat Pellets**

8.213.2 15,-

**Kniendrolle „TRUTTMAN Grip“ Ø120 mm, mit Granulat  
Kneelingrole „TRUTTMANN Grip“ Ø120 mm, with pellets**



8.214.1 65,-

**Kniendrolle „TRUTTMAN Grip“ Ø160 mm, mit Granulat  
Kneelingrole „TRUTTMANN Grip“ Ø160 mm, with pellets**

8.214.2 65,-



**Diopter centra ,SPY SHORT'** silber, mit Gegenlichtblende  
*Rearsight centra ,SPY SHORT'* , silver, with lenshood



**6.311 526,-**

**Diopter centra ,SPY SHORT'** schwarz, mit Gegenlichtblende  
*Rearsight centra ,SPY SHORT'* , black, with lenshood



**6.311b 526,-**

**Diopter centra ,SPY LONG'** silber, mit Gegenlichtblende  
*Rearsight centra ,SPY LONG'* , silver, with lenshood



**6.311.2 526,-**

**Diopter centra ,SPY LONG'** schwarz, mit Gegenlichtblende  
*Rearsight centra ,SPY LONG'* , black, with lenshood



**6.311.2b 526,-**

**Diopter centra ,SPY CROMO'** Edelstahl und Titan  
*Rearsight centra ,SPY CROMO'* , stainless steel and Titanium



**6.311.1 870,-**

**DUPLEX for centra ,SPY'**, zweiter Ring  
*DUPLEX for centra ,SPY'* , second ring



**6.311.3 170,-**

**Einsätze für DUPLEX**, verschiedene Größen und Farben  
*Inserts for DUPLEX* , different sizes and colors



**6.311.4 28,-**

**DUPLEX VARIO for centra ,SPY'**, 3,4 - 4,4 mm oder 3,8 - 4,8 mm  
*DUPLEX for centra ,SPY'* , 3,4 - 4,4 mm or 3,8 - 4,8 mm



**6.311.5 284,-**

**Diopter centra ,NAVIGATOR CLUB'** schwarz oder metallic  
*Rearsight centra ,NAVIGATOR CLUB'* , black or metallic



**6.311.6 265,-**

**Diopter centra ,NAVIGATOR SR'** schwarz oder metallic  
mit Schnellspanverschluss  
*Rearsight centra ,NAVIGATOR SR'* , black or metallic  
with rapid fix system



**neu  
2017  
new**

**6.311.9 310,-**

**Diopter centra ,NAVIGATOR Sprint'** schwarz oder metallic  
langer Fuß, Filterklappe, auch für Biathlon  
*Rearsight centra ,NAVIGATOR SR'* , black or metallic  
long base, trap filter, for biathlon too



**6.311.7 412,-**

**Lenshood II**, zur Montage des Duplex an NAVIGATOR  
*Lenshood II for mounting Duplex at NAVIGATOR*



**6.311.8 45,-**

**Diopter HÄMMERLI**  
*Rearsight HÄMMERLI*



**6.330 640,-**

**Diopter SWISS ARMS**  
*Rearsight SWISS ARMS*

**6.340 580,-**





alle Irisblenden unten in silber oder schwarz



all sights below in black or silver

Irisblende centra **,3.0 BASIC'** 0.5 - 3.0 mm, in silber und schwarz  
Sight centra **,3.0 BASIC'**, 0.5 - 3.0 mm, silver and black



**6.211.1**    **72,-**

Irisblende centra **,3.0 Pol'** 0.5 - 3.0 mm, mit Polarisationsfilter  
Sight centra **,3.0 Pol'**, 0.5 - 3.0 mm, integrated polarization-filter



**6.211.2**    **142,-**

Irisblende centra **,3.0 FILTER'** 0.5 - 3.0 mm, 5 Farben Filter  
Sight centra **,3.0 FILTER'**, 0.5 - 3.0 mm, 5 color filter



**6.211.3**    **148,-**

Irisblende centra **,3.0 COMBI'** 0.5 - 3.0 mm, 5 Farben Filter, Polarisationsfilter  
Sight centra **,3.0 COMBI'**, 0.5 - 3.0 mm, 5 color filter, polarization-filter



**6.211.4**    **175,-**

Irisblende centra **,1.8 TWIN'** 0.8 - 1.8 mm, 10 Filter Farben  
Sight centra **,1.8 TWIN'**, 0,8 - 1,8 mm, 10 color filter



**6.212.1**    **178,-**

Irisblende centra **,1.8 INDOOR'** 0.8 - 1.8 mm, 5 Filter Farben, speziell für Hallen  
Sight centra **,1.8 INDOOR'**, 0,8 - 1,8 mm, 5 color filter, special for indoor ranges



**6.212.2**    **142,-**

Irisblende centra **,1.8 COMPETITION'** 10 Filter Farben, Polarisationsfilter  
Sight centra **,1.8 COMPETITION'**, 10 color filter, polarization-filter



**6.212.3**    **199,-**

Irisblende centra **,1.8 PERFORMANCE'** 5 Filter Farben, Polarisationsfilter  
Tunnelfilter  
Sight centra **,1.8 PERFORMANCE'**, 5 color filter, polarization-filter,  
front sight tunnel filter



**6.212.4**    **208,-**

Irisblende centra **,1.8 TINY'** 5 Filter Farben, kleinste Bauart  
Sight centra **,1.8 TINY'**, 5 color filter, small diameter



**6.212.5**    **182,-**

Irisblende centra **,1.8 SUPER AR I'** 5 Filter Farben, UV 400 beschichtet,  
superentspiegelt  
Sight centra **,1.8 SUPER AR I'** 5 color filter, UV-400 coated,  
super anti-reflection



**6.212.6**    **217,-**

Irisblende centra **,1.8 SUPER AR II'** 10 Filter Farben, UV 400 beschichtet,  
superentspiegelt  
Sight centra **,1.8 SUPER AR II'** 10 color filter, UV-400 coated,  
super anti-reflection



**6.212.7**    **317,-**

MEC GLAS **,MONOCLE'** fixiert das Brillenglas vor der Iris  
MEC GLAS **,MONOCLE'** fits the lens in front of the rearsight



**6.214**    **84,-**

MEC GLAS **,MONOCLE REVOLVE'** fixiert das Brillenglas vor der Iris,  
360 Grad Drehung des Glases zum Ausgleich bei Astigmatismus  
MEC GLAS **,MONOCLE REVOLVE'**, fits the lens in front of the rearsight,  
360 degree rotation to balance astigmatism



**6.214.1**    **172,-**



Die internationalen Regel und viele nationale Sportordnungen gestatten den Anbau des Brillenglases direkt vor der Irisblende.

International Rules and most national shooters to mount a lens on the rearsight.





Erhöhung 4mm **,BLEIKER'** für Korntunnel  
*Elevation 4 mm ,BLEIKER' frontsight*



6.240 28,-

Erhöhung centra **,BLOCK 4'** hebt Diopter und Korntunnel um 4 mm  
*Elevation centra ,BLOCK 4' raises Rear- and Frontsight 4 mm*



6.241 49,-

Erhöhung centra **,BLOCK 8'** hebt Diopter und Korntunnel um 8 mm  
*Elevation centra ,BLOCK 8' raises Rear- and Frontsight 8 mm*

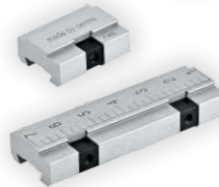

6.242 74,-

Erhöhung centra **,RAISER'** hebt Diopter und Korntunnel um 8 mm  
*Elevation centra ,RAISER' raises Rear- and Frontsight 8 mm*



6.243 81,-

Erhöhung centra **,TRACK'** hebt Diopter und Korntunnel um 9 mm,  
zusätzlich stufenlose seitliche Verschiebung  
*Elevation centra ,TRACK' raises Rear- and Frontsight 9 mm,  
infinitely side adjustment*

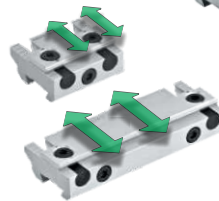

6.244 113,-

Erhöhung centra **,CLUB'**, Grundhöhe 10 mm, + 3 x 4 mm, maximal 22 mm  
seitlich in einem Schritt 4mm, mögliche Rückverlagerung 25 mm

*Elevation centra ,CLUB', Base height 10 mm, + 3 x 4 mm, final height 22 mm,  
horizontal offset (one step) 4mm, rearsight dovetail can shift 25 mm*

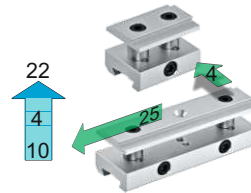

6.245 98,-

Erhöhung centra **,BLOCK 8 SPEED'**, hebt Diopter und Korntunnel um 8 mm,  
schnelle Montage durch 'Handschrauben'

*Elevation centra ,BLOCK 8 SPEED', raises Rear- and Frontsight 8 mm,  
installation without tools*



6.246 112,-

**,BLOCK CLUB SPEED'**, Grundhöhe 10 mm, + 3 x 4 mm, maximal 22 mm  
seitlich in einem Schritt 4 mm, Rückverlagerung 25 mm, schnelle Montage

*,BLOCK CLUB SPEED', Base height 10 mm, + 3 x 4 mm, final height 22 mm,  
horizontal offset (one step) 4 mm, rearsight shift 25 mm, installation without tools*



6.247 138,-

**,TELE FLIGHT'**, Grundhöhe 11 mm, + 3 x 4 mm, maximal 23 mm  
seitlich in einem Schritt 4mm, Rückverlagerung 45 mm,  
auch für die Montage eines Zielfernrohr

*,TELE FLIGHT', Base height 11 mm, + 3 x 4 mm, final height 23 mm,  
horizontal offset (one step) 4mm, additional length 45 mm,  
possibility to mount a scope*



6.249 138,-

**,SPEED KIT BLOCK X'**, für BLOCK 8, BLOCK CLUB, BLOCK MAX, TELE FLIGHT  
*,SPEED KIT BLOCK X', for BLOCK 8, BLOCK CLUB, BLOCK MAX, TELE FLIGHT*



6.248 48,-

**,BLOCK CLUB SR'**, Grundhöhe 11 mm, + 3 x 4 mm,  
maximal 24 mm, seitlich in einem Schritt 4mm,  
Rücklagerung 25 mm, Montage mit Schnappverschluss

*,BLOCK CLUB SR', Base height 11 mm, + 3 x 4 mm,  
final height 24 mm, horizontal offset (one step) 4mm,  
rearsight shift 25 mm, installation without tools*



6.247.1 220,-



**BLEIKER Kornfuß A**  
**BLEIKER front sight base A**



6.110 85,-

**Flansch B** für BLEIKER Kornfuß  
**Flange B** BLEIKER front sight base

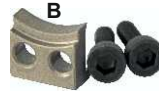

6.110.2 20,-

**BLEIKER KORNTUNNEL**, ohne Fuß  
**BLEIKER FRONTSIGHT-TUNNEL**, without base



6.120 44,-

**,ANTIGLARE-TUBE'**, Gegenlichtblende, auf für Duo- Ringkorne  
**,ANTIGLARE-TUBE'**, for mounting lenses, filters, spirit bubbler, eagle-eyes,...



6.120.2 40,-

**,SCORE CRISTAL'**, transparenter Korntunnel für optimalen Kontrast,  
ohne Kornfuss

**,SCORE CRISTAL'**, transparent tunnel for better brightness,  
without base



6.120.3 111,-

**,SCORE'**, stufenlos drehbar, Querstifte,  
M18 und M22, in 4 Farben

**,SCORE'**, swivels on the axle, cross pins,  
M18 and M22, in 4 colors



6.120.4 89,-

**,SCORE COMPOSITE'**, stufenlos drehbar, Querstifte,  
M18 und M22, transparenter Korntunnel für optimalen Kontrast

**,SCORE COMPOSITE'**, swivels on the axle, cross pins,  
M18 and M22, transparent tunnel for better brightness



6.120.5 120,-

**,GLAS-CUBE'**, transparenter Würfel mit außergewöhnlicher Zielwahrnehmung. Drehung und seitliche Verschiebung, alle Anbauten möglich.

**,GLAS-CUBE'**, transparent cube with extraordinary perception. Turnable and horizontal move.

neu  
2017  
new



6.120.6 179,-

**,GLAS-CUBE IL'**, transparenter Würfel mit zusätzlicher Wasserwaage  
centra **,GLAS-CUBE IL'**, transparent cube with integrated bubble



6.120.7 199,-

**,LEVEL'**, Wasserwaage, Justierung ohne Werkzeug, gut zu erkennen

**,LEVEL'**, spirit bubble, adjustment without tool, good perception



6.231 76,-

**,LEVEL 2'**, Innen-Wasserwaage, Justierung ohne Werkzeug, verlängert Korntunnel

**,LEVEL 2'**, internalbubble, adjustment without tool, antiglare tube



6.232 81,-

**,LIB-LIGHT'**, Beleuchtung für ,LEVEL', wird bei Bedarf aufgesteckt, Helligkeit regelbar, M18 und M22

**,LIB-LIGHT'**, illuminator for Level, can be attached if necessary, adjustable brightness, M18 and M22



6.234 73,-

**,ARTHOR'**, Richtkreuz, Justierung ohne Werkzeug, verlängert Korntunnel

**,ARTHOR'**, artificial horizont, adjustment without tool, antiglare tube



6.235 66,-

**,ROTARY'**, 2 weiche Schutzkappen, M18 und M22 (für Irisblende)

**,ROTARY'**, 2 soft covers, M18 and M22 (for sights)



M18 6.226 8,-

M22 6.226.2 8,-

**„HIGH END CIRCLE“** geschliffenes Glasringkorn mit reflexfreiem Korneinsatz, Grosskaliber tauglich, in M18 und M22 lieferbar  
 Korndurchmesser: 3,0 - 7,5 in 0,1 mm Schritten  
 Ringbreiten: 1,0 - 1,4 in 0,1 mm Schritten  
 Es gibt kein klareres Zielbild als mit einem feststehenden Ring.

**„HIGH END CIRCLE“** polished glass, refractive free ring insert, suitable for large caliber  
 Ring diameter : 3,0 - 7,5 in 0,1 mm steps  
 Ring widths: 1,0 - 1,4 in 0,1 mm Schritten  
 There is no better perception than with a fix ring.

**„HIGH END CIRCLE“** wie oben, aber in gelb, blau oder rot  
**„HIGH END CIRCLE“** like above, but in yellow, blue or red

**„HIGH END SQUARE“** geschliffenes Glaskorn, quadratischer Einsatz, Grosskaliber tauglich, in M18 und M22 lieferbar, speziell für Auflage  
 Korndurchmesser: 3,0 - 7,5 in 0,1 mm Schritten  
 M22 auch Korndurchmesser: 7,6 - 10,0 in 0,1 mm Schritten

**„HIGH END SQUARE“** polished glass, refractive free sqare/ring insert, suitable for large caliber  
 Ring diameter : 3,0 - 7,5 in 0,1 mm steps  
 M22 as well Ring diameter : 7,6 - 10,0 in 0,1 mm steps

**„HIGH END CRYSTAL“** geschliffenes Glas mit reflexfreiem Korneinsatz, GK tauglich, in M18 und M22 lieferbar, transparente Fassung  
 Korndurchmesser: 3,0 - 7,5 in 0,1 mm Schritten  
 Ringbreiten: 1,0 - 1,4 in 0,1 mm Schritten  
 Für Tunnel „SCORE CRYSTAL“ und „GLAS CUBE“

**„HIGH END CRYSTAL“** polished glass, refractive free ring insert, suitable for large caliber, clear frame  
 Ring diameter : 3,0 - 7,5 in 0,1 mm steps  
 Ring widths: 1,0 - 1,4 in 0,1 mm Schritten  
 For „SCORE CRYSTAL“ and „GLAS-CUBE“

**„HIGH END CRYSTAL“** wie oben, aber in gelb, blau oder rot  
**„HIGH END CRYSTAL“** like above, but in yellow, blue or red

**„Filter FS“** Farbfilter für Korntunnel, gelb, rot und blau  
**„Filter FS“** Color filter glass for front sight tunnel,

**„POLARIZER SINGLE“** Polfilter für Korntunnel, reguliert in Verbindung mit SIGHT 1.8 PERFORMANCE die Helligkeit im Zielbild

**„POLARIZER SINGLE“** pol-filter for front sight tunnel, regulates contrast and reduces glare in connection with SIGHT 1.8 PERFORMANCE

**„KORNBOX WOOD“** Holzcontainer zur Aufbewahrung von 10 Ringkornen, Filtern oder Ähnlichem in M18 und M22

**„KORNBOX WOOD“** wodden container for 10 High End rings or similliar, M18 and M22

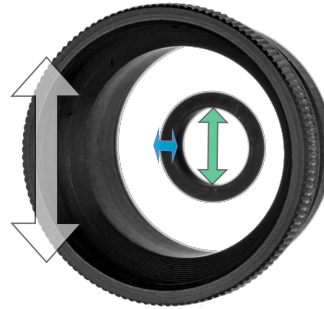

**3,0 - 7,5mm  
1,0 - 1,4mm**

+ M18  
M22

6.227 25,-



6.227.1 35,-



6.227.2 27,-

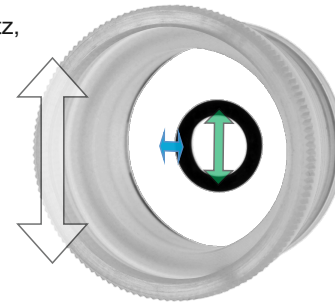

**3,0 - 7,5mm  
1,0 - 1,4mm**

+ M18  
M22

6.227.3 29,-



6.227.4 39,-



gelb/yellow 6.213.1 37,-

rot/red 6.213.2 37,-

blau/blue 6.213.3 37,-



M18 6.213.4 29,-

M22 6.213.5 29,-



6.228 59,-

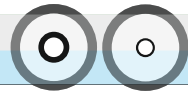

**STANDARD**, Iris-Ringkorn in silber und schwarz, Balken 0,5 mm



M18/1.6	2.8 - 4.8	6.221.2	111,-
M18/2.0	2.8 - 4.8	6.221.3	111,-
M18/2.0	3.8 - 5.8	6.221.4	111,-

**STANDARD**, Iris front sight ring beam 0.5 mm in silver and black



M18/1.2	2.8 - 3.8	6.222.6	142,-
M18/1.2	3.4 - 4.4	6.222.7	142,-
M18/1.2	3.8 - 4.8	6.222.8	142,-

**IRIS-GLAS**, verstellbares Ringkorn aus geschliffenem Glas, gleichbleibende Ringbreiten nach Wahl

M18/1.6	1.8 - 4.3	6.222.1	146,-
M18/1.6	2.3 - 4.3	6.222.2	146,-
M18/1.6	2.8 - 4.8	6.222.3	146,-

**IRIS-GLAS**, variable iris front sight ring, constant ring width of choice, polished glass

M18/2.0	2.8 - 4.8	6.222.14	146,-
M18/2.0	3.8 - 5.8	6.222.5	146,-

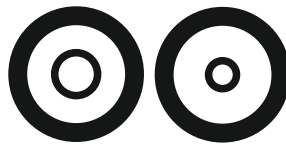

M22/2.0	2.8 - 4.8	6.222.42	146,-
M22/2.0	3.8 - 5.8	6.222.52	146,-

**DUO-VARIO**, Innen- und Außendurchmesser des Rings getrennt verstellbar, Kreuz oder Balken, Verkantung einstellbar

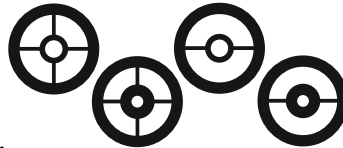

	Ø innen	Ø außen		
M18	2.8 - 4.8	6.4 - 9.0	6.223.1	202,-
M18	3.8 - 5.8	7.6 - 10.2	6.223.2	202,-
M22	2.8 - 4.8	6.4 - 9.0	6.223.3	202,-
M22	3.8 - 5.8	7.6 - 10.2	6.223.4	202,-

**Duo Vario**, inside and outside diameter of the ring separate variable, cross hairs or cross beam, simple setting of canting

Ø innen    Ø außen  
inside      outside

**DUO-GLASS**, geschliffenes Glas, Innen- und Außendurchmesser verstellbar, Querstifte einsetzbar, Verkantung einstellbar



	Ø innen	Ø außen		
M18	2.8 - 4.8	6.4 - 9.0	6.224.1	202,-
M18	3.8 - 5.8	7.6 - 10.2	6.224.2	202,-
M22	2.8 - 4.8	6.4 - 9.0	6.224.3	202,-
M22	3.8 - 5.8	7.6 - 10.2	6.224.4	202,-

**Duo GLASS**, polished glass, inside and outside diameter separate variable, cross pins insertable, simple setting of canting

Ø innen    Ø außen  
inside      outside

**SQUARE GLAS**, geschliffenes Glas, verstellbarer Innenring, mit quadratischer Außenkontur



M18	2.8 - 4.8	6.225.1	170,-
M18	3.8 - 5.8	6.225.2	170,-

**Duo GLASS**, polished glass, adjustable front sight ring with square outline

M22	2.8 - 4.8	6.225.3	170,-
M22	3.8 - 5.8	6.225.4	170,-



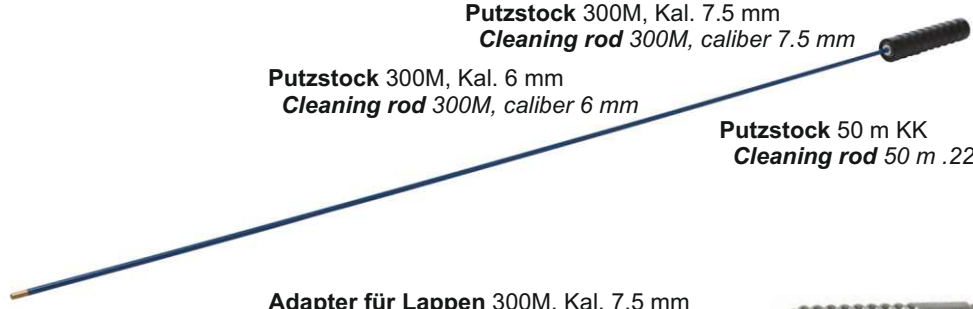

**Putzstock 300M, Kal. 7.5 mm**  
*Cleaning rod 300M, caliber 7.5 mm*

7.111.1 85,-

**Putzstock 300M, Kal. 6 mm**  
*Cleaning rod 300M, caliber 6 mm*

7.111.2 85,-

**Putzstock 50 m KK**  
*Cleaning rod 50 m .22*

7.112 85,-

**Adapter für Lappen 300M, Kal. 7.5 mm**  
*Adapter 300M, caliber 7.5 mm*



7.113.1 5,-

**Adapter für Lappen 300M, Kal. 6 mm. und KK**  
*Adapter 300M, caliber 6 mm and .22*



7.113.2 5,-

**Adapter für VFG 300M und KK**  
*Adapter for VFG 300M and .22*



7.113.3 5,-

**Bronzebürste 300M, Kal. 7.5mm mit Außengewinde, für BLEIKER Putzstock**  
*Bronzebrush 300M, caliber 7.5mm for BLEIKER cleaning rod*



7.116.1 9,-

**Bronzebürste 300M, Kal. 7.5mm, Innengewinde (Armee)**  
*Bronzebrush 300M, caliber 7.5mm, female thread (Swiss Army)*



7.116.3 9,-

**Bronzebürste KK**  
*Bronzebrush .22*



7.116.2 9,-

**Putzstockführung 300M, Kal. 7.5mm, Modell 1995 - 2004)**  
*Cleaning rod guide 300M, caliber 7.5mm*



7.114.1 38,-

**Putzstockführung 300M, Kal. 7.5mm Modell ab 2005**  
*Cleaning rod guide 300M, caliber 7.5mm*



7.114.2 38,-

**Putzstockführung 300M, Kal. 6 mm BR**  
*Cleaning rod guide 300M, caliber 6 mm BR*



7.114.3 38,-

**Putzstockführung KK, .22**  
*Cleaning rod guide .22*

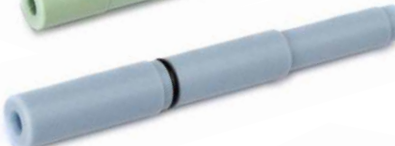

7.114.4 38,-

**Putzstock Länge 300 mm für Putzstockführung und Patronenlager**  
*Cleaning rod 300mm for rod guide and cartridge bearings*



7.115.1 33,-



**Wollwischer für Laufhülse**  
*Wool brush for tube*



7.115.2 11,-

**Bronzebürste Laufhülse**  
*Bronzebrush tube*



7.115.3 11,-

**Wollwischer für Patronenlager**  
*Wool brush cartridge bearings*



7.115.5 9,-

**Bronzebürste für Patronenlager**  
*Bronzebrush cartridge bearings*



7.115.6 10,-

**Reinigungsset Laufhülse mit Putzstock**  
Wollwischer und Bronzebürste  
*Cleaning set tube with rod, wool-brush and bronze-brush*

7.115 49,-



**Putzsnur und Putzdochte für LG und LP**  
*Putzcord and putzwick for air rifle and air pistol*



7.121 24,-

**Putzdochte für LG und LP**  
*Putzwick for air rifle and air pistol*

7.122 10,-

**VFG Laufreiniger in verschiedenen Kalibern**  
*VFG barrel in different calibers*

**VFG SI superintensiv, mit Messingfasern**  
*VFG SI superintensive, with brass fibers*



VFG	7.5 mm	50 Stk.	7.141.2	9,-
VFG	7.5 mm	500 Stk.	7.141	44,-
VFG-SI	7.5 mm	50 Stk.	7.142.1	18,-
VFG-SI	7.5 mm	500 Stk.	7.142.2	96,-
VFG	6 mm	50 Stk.	7.146.1	9,-
VFG	6 mm	500 Stk.	7.146.2	36,-
VFG	KK .22lr	80 Stk.	7.143.2	9,-
VFG	KK .22lr	500 Stk.	7.143.1	36,-
VFG-SI	KK .22lr	80 Stk.	7.144.1	18,-
VFG-SI	KK .22lr	500 Stk.	7.144.2	73,-
VFG	LG 4.5mm	100 Stk.	7.145.1	7,-
VFG	LG 4.5mm	500 Stk.	7.145.2	20,-

**Gun Oil** penetrants and friction reducing additives combined with enhanced rust and corrosion inhibitors. Friction Guard XP offers unsurpassed lubrication and complete metal conditioning under the most extreme conditions

**Rimfire Blend** is a cutting edge bore cleaner that is 100% barrel safe, biodegradable and easily outperforms the competition without any hazards, toxicities or odors. Rimfire Blend removes the carbon, lead and bullet wax fouling produced by Rimfire ammunition.

**Copper Remover** rapidly removes copper fouling and is 100% barrel safe, odor free and biodegradable. It is ammonia free and removes heavy copper fouling faster than the competition without the safety hazards, harmful toxicity, and offensive odors found in petro-ammonia based solvents.

**Moly Magic** is the only cleaner in the industry formulated specifically to assist in the removal of moly fouling/buildup in rifle bores. The unique blend of penetrants and surfactants allows the Moly Magic to quickly and effectively neutralize harmful corrosives and remove stubborn moly fouling.

**Carbon Remover** sets the standard for cutting edge carbon cleaners that immediately begins to eliminate heavy carbon fouling without the safety hazards, harmful toxicity, and offensive odors typically found in competitive cleaners. Stubborn baked-on carbon fouling in rifle throats, AR bolt-tails and shotgun gas pistons are no match for the C4 Carbon Remover.

**Gun Oil** verschleißt erwärmte Oberflächen mit einer Beschichtung aus Teflon und verhindert Ablagerungen.

**Rimfire Blend** löst Blei- und Pulverrückstände. Vor allem für die Reinigung von Kleinkalibergewehren geeignet.

**Copper Remover** Kupfer-Löser. Reinigt ohne Ammoniak, ungefährlich, geruchsneutral und biologisch abbaubar.

**Moly Magic** ist eine Kombination zur Reinigung von abgelagerten Molybdän-Schwefelkohlestoffen.

**Carbon Remover** zur Lösung von Rußpartikeln. Für Lauf, Verschluss, Laufhülsen und Gehäuse.

7.221 25,-

7.223 25,-

7.227 25,-

7.226 25,-

7.228 25,-

**Brunox Waffenpflege Turbospray**  
*Brunox Gun care spray*



100 ml 7.231.1 11,-

500 ml 7.231.2 16,-

**BLEIKER Putzbock für alle Gewehre**  
*BLEIKER Cleaning Support for all rifles*

7.510 140,-



Kunststoffkoffer **,Elegance'** 120 x 25 x 10 cm  
RIFLE case **,Elegance'**, 120 x 25 x 10 cm



8.312 110,-

Kunststoffkoffer **,Robust'** 120 x 30 x 13 cm  
RIFLE case **,Elegance'**, 120 x 30 x 13 cm



8.313 136,-

Kunststoffkoffer **,System'** 85 x 12 x 8 cm für ein System  
RIFLE case **,System'**, 85 x 12 x 8 cm for one action



8.314 43,-

Futteral **,Truttmann normal'** 124 x 6 x 28cm  
Sheath **,Truttmann normal'** 124 x 6 x 28cm



8.241 129,-

Futteral **,Truttmann long'** 132 x 6 x 30cm  
Sheath **,Truttmann long'** 132 x 6 x 30cm



8.242 139,-

Futteral **,Truttmann long'** mit Stofffütterung  
Sheath **,Truttmann long'** with cloth inlet



8.242.1 139,-

Futteral **,Truttmann Tafu'** für Standardgewehr  
Sheath **,Truttmann Tafu'** for Swiss Standardrifle



8.243 220,-

Schießtasche **,Truttmann Athen'** mit Rollen, 80 x 34 x 38 cm  
Shooting-Bag **,Truttmann Athen'** with roles, 80 x 34 x 38 cm



8.221 198,-

Schießtasche **,Truttmann 205'** mit Rädern, 83 x 34 x 38 cm  
Shooting-Bag **,Truttmann 205'** with wheels, 83 x 34 x 38 cm



8.222 249,-

Schießtasche **,Truttmann 35'** 57 x 29 x 38 cm  
Shooting-Bag **,Truttmann 35'** 57 x 29 x 38 cm



8.223 119,-

Schießtasche **,Truttmann 40'** 66 x 32 x 38 cm  
Shooting-Bag **,Truttmann 40'** 66 x 32 x 38 cm



8.224 139,-

Rucksack **,Truttmann klein'** 38 x 24 x 54 cm  
Rucksack **,Truttmann groß'** 38 x 24 x 68 cm  
Rucksack **,Truttmann small'** 38 x 24 x 54 cm  
Rucksack **,Truttmann small'** 38 x 24 x 68 cm



8.231 149,-

8.232 180,-



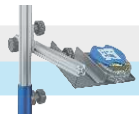

Peltor Gehörschutz **,OPTIME I'**, gelbe Kapseln, faltbar, Dämmwert SNR = 26dB  
*Peltor Earmuffs ,Optime I'*, yellow, foldable, protection of SNR = 26dB



8.711 37,-

Peltor Gehörschutz **,OPTIME II'**, faltbar, Dämmwert SNR = 30dB  
*Peltor Earmuffs ,Optime II'*, foldable, protection of SNR = 30dB



8.712 43,-

Peltor Gehörschutz **,OPTIME III'**, nicht faltbar, Dämmwert SNR = 35dB  
*Peltor Earmuffs ,Optime III'*, not foldable, protection of SNR = 35dB



8.713 40,-

Peltor Gehörschutz **,KID'**, neon-pink, SNR = 27dB  
*Peltor Earmuffs ,KID'*, neon-pink, SNR = 27dB



8.715.2 31,-

Peltor Gehörschutz **,KID'**, neon-grün, SNR = 27dB  
*Peltor Earmuffs ,KID'*, neon-green, SNR = 27dB



8.715 31,-

Peltor Gehörschutz **,Bulls Eye'**, grün, SNR = 35dB,  
 für Schützen entwickelt, mit Abschrägung zum Schaft  
*Peltor Earmuffs ,Bulls Eye'*, grün, SNR = 35dB,  
 for shooters, with a bevel to the stock



8.716 36,-

Peltor Gehörschutz **,Bulls Eye'**, rot, SNR = 35dB,  
 für Schützen entwickelt, mit Abschrägung zum Schaft  
*Peltor Earmuffs ,Bulls Eye'*, red, SNR = 35dB,  
 for shooters, with a bevel to the stock



8.716.2 36,-

3M, zwei Gehörschutzstöpsel **,Classic'**, SNR = 36dB  
 2 Ear plugs **,Classic'**, SNR = 36dB



8.721 1,-

3M, zwei Gehörschutzstöpsel **,Ultrafit'**, SNR = 29dB  
 2 Ear plugs **,Classic'**, SNR = 36dB



8.722 5,-



MEC **,STATIV'**, Tasche  
 sehr stabil  
*MEC Tripod ,Stativ'*,  
 with bag, solid

8.816 299,-



**SE Stativ mit Tasche**  
**SE Tripod with bag**

8.812 218,-







ELEY **‘TENEX’** KK-Munition  
*ELEY ‘TENEX’ .22 Ammunition*



1000	9.211	344,-
------	-------	-------

5000	9.211	1625,-
------	-------	--------

ELEY **‘SPORT’** KK-Munition  
*ELEY ‘SPORT’ .22 Ammunition*



1000	9.213	142,-
------	-------	-------

5000	9.213	650,-
------	-------	-------

RWS **‘R 50’** KK-Munition  
*RWS ‘R 50’ .22 Ammunition*



1000	9.221	340,-
------	-------	-------

5000	9.221	1565,-
------	-------	--------

Lapua **‘Center-X’** KK-Munition  
*Lapua ‘Center-X’ .22 Ammunition*



1000	9.226.1	213,-
------	---------	-------

5000	9.226.2	1010,-
------	---------	--------

KK-Manipulierpatrone für das Trockentraining, 10 Stk.  
*.22 Tbuffer cartridge for dry firing, 10 pieces*



10	9.230	9,-
----	-------	-----

KK **‘Zimmi box’** für 150 Schuss, ELEY außer TENEX  
*.22 ‘ZIMMI box’, for 150 rounds, ELEY but not TENEX*



9.521.1	48,-
---------	------

KK **‘Zimmi box’** für 150 Schuss RWS  
*.22 ‘ZIMMI box’, for 150 rounds RWS*

9.521.2	50,-
---------	------



KK Munitionstest inklusiv 50 Schuss  
*.22 Ammunition test inclusiv 50 rounds*

11.212.1	80,-
----------	------

KK Munitionstest 10 Schuss zusätzlich  
*.22 Ammunition additional 10 rounds*

11.212.2	8,-
----------	-----

LG Munitionstest inklusiv Munition  
*AR Ammunition test inclusiv ammunition*

11.410	40,-
--------	------

RWS **‘R 10’** LG Topmunition  
*RWS ‘R 10’ Air rifle top ammunition*



5000	9.421.1	145,-
------	---------	-------

RWS **‘CLUB’** LG Vereinsmunition  
*RWS ‘CLUB’ Air rifle club ammunition*



5000	9.422.2	75,-
------	---------	------

LG **‘Finale’** Munitionsbox für 100 Diabolos  
*AR ‘Finale’ Pellets box for 100 diabolos*



9.522.1	28,-
---------	------

MEC **‘AIR PUCK’** Aluminium Dose für 500 Diabolos  
*MEC ‘AIR PUCK’ aluminium tin for 500 pellets*



9.522.2	49,-
---------	------



**GP11, 7.5 x 55 RUAG SWISS-MATCH**

**20 9.111**

Preis auf Anfrage  
Price on request



**6mmBR Norma**

**50 9.121**

Preis auf Anfrage  
Price on request



**6XC Norma**

**50 9.121.2**

Preis auf Anfrage  
Price on request



**6.5 x 47 Lapua Match**

**20 9.131**

Preis auf Anfrage  
Price on request



**6mmBR Lapua**

**20 9.121.2**

Preis auf Anfrage  
Price on request

Manipulierpatrone für das Trockentraining  
.22 Tbuffer cartridge for dry firing



**6mmBR**

**1 9.112.2 15,-**

**GP11, 7.5 x 55**

**1 9.112 15,-**

**GP 11 Munitionsbox** Kunststoff, 50 Patronen  
**GP 11 Ammunition Box, Plastic, 50 cartridges**



**9.511.1 15,-**

**GP 90 Munitionsbox** Kunststoff, 100 Patronen  
**GP 90 Ammunition Box, Plastic, 100 cartridges**



**9.512.1 15,-**

**300M Service** (empfohlen jährlich): Optische Kontrolle, Reinigung, Kontrolle der Lagerungen und Systemschrauben, allgemeine Schaftkontrolle, Abzugseinstellung

**300M Service** (every year): Optical check, cleaning, screw adjustment, stock and trigger control

**300M**

**Lauf Ausmessung** mit Protokoll **Barrel measurement** with report

**Diopter Ausmessung** **Diopter measurement**

**GP 11 Laufwechsel** mit komplettem Service **GP 11 Barrel change** with complete Service

**6 mm Laufwechsel** mit komplettem Service **6 mm Barrel change** with complete Service

**300M CIP Prüfung** **300 M CIP Test**

**300M Schussbild** **300 M Test group**

**Schwerer Lauf, Ø 23mm** **Heavy barrel, Ø 23mm**

**11.120 120,-**

**11.131 35,-**

**11.131.2 20,-**

**11.132 1350,-**

**11.133 1350,-**

**11.140 70,-**

**11.110 90,-**

**5.111.91 100,-**

**KK Service** (jährlich): Optische Kontrolle, Reinigung, Lagerungen, Abzugseinstellung

**.22 Service** (every year): Optical check, cleaning, screw adjustment, stock and trigger control

**50M**

**KK Einschossen** inkl. 50 Schuss **.22 Ammunition test** incl. 50 rounds

**10 Schuss zusätzlich** **10 rounds more**

**Laufreinigung** mit Entbleien **Barrel cleaning** with special lead procedure

**KK Laufwechsel** mit komplettem Service **.22 Barrel change** with complete Service

**KK CIP Prüfung** **.22 CIP Test**

**KK Schussbild** **.22 Test group**

**11.211 120,-**

**11.212.1 80,-**

**11.212.2 8,-**

**11.221 35,-**

**11.233 950,-**

**11.240 70,-**

**11.222 80,-**

**10M**

**LG Einschossen** inkl. Munition **Air Rifle Ammunition test** incl. ammunition

**Laufreinigung** mit Entbleien **Barrel cleaning** with special lead procedure

**11.410 40,-**

**11.411 25,-**



Schild-Mütze ,Truttmann ISSF/RSPS'  
*Shield cap ,Truttmann ISSF/RSPS'*

13.150.1 48,-



Schild-Mütze ,Truttmann ISSF/RSPS' mit Schweißband  
*Shield cap ,Truttmann ISSF/RSPS' with sweat strap*

13.150.2 48,-



Neoprenkappe ,Truttmann'  
schwarz, blau, rot, gelb, pink, grün  
*Neopren-cap ,Truttmann'*  
*black, blue, red, yellow, pink, green*

13.151.2 18,-

Stirnband ,Champion' ohne Clip und Blende  
*Headband ,Champion' without clip and blinder*



13.160 12,-

Stirnband ,Champion' mit Clip  
*Headband ,Champion' with clip*

13.161 18,-

Stirnband ,Champion' mit Clip und Abdeckung transparent+grau  
*Headband ,Champion' with clip and blinder transparent+grey*



13.162.3 42,-

Stirnband ,Champion' mit Clip und Abdeckung transparent  
*Headband ,Champion' with clip and blinder transparent*



13.162.2 32,-

Stirnband ,Champion' mit Clip und Abdeckung grau  
*Headband ,Champion' with clip and blinder grey*



13.162.1 32,-

Seitenabdeckung Stirnband ,Champion'  
(nicht ISSF zugelassen)  
*Side Blinder Headband ,Champion'*  
*(not allowed in ISSF competitions)*



13.162.4 20,-

Knöpfe BLEIKER, verschiedene Farben  
*Buttons BLEIKER, different Colors*



blau / blue	13.100.1	7,-
grün / green	13.100.2	7,-
grau / grey	13.100.3	7,-
rot / red	13.100.6	7,-
silber / silver	13.100.7	7,-
schwarz / black	13.100.8	7,-
gelb / yellow	13.100.9	7,-
weiss / white		7,-

**SCATT** - Training System für statische Scheiben  
- Für Trockentraining und mit scharfem Schuss  
- Für Indoor und Outdoor Einsatz  
- Mit herkömmlichen Scheiben oder einer elektronischen Anlage (wie z.B. Meyton, Sius-Ascor, Disag, Häring)  
**Lieferumfang: siehe unten**  
Optischer Sensor MX-02 für 10, 25 und 50 Meter  
Mounting Kit für den optischen Sensor  
Verbindungskabel

**SCATT MX-02** **SCATT MX-02** 17.100.3 1990,-

**SCATT WS1 ohne Kabel** **SCATT WS1 wireless** 17.100.4 1795,-



**SCATT** electronic computer trainer  
- For shooting practice with fixed targets  
- Train dry fire mode or in live fire  
- Indoors and at open shooting ranges  
- Paper target or target installation (i.e. SIUS)  
**Contents: see below**

**BLEIKER SCATT Adapter**  
*BLEIKER SCATT Adapter*



17.101 145,-

Optical Sensor MX-02 ready for 10, 25 and 50 meter  
Mounting kit for the optical sensor  
Optical sensor's interface cable

**Laufeinsatz 5.56 mm** **Barrel insert 5.56 mm** 17.110.1 35,-

**Laufeinsatz 7.5 mm** **Barrel insert 7.5 mm** 17.110.2 35,-

**Trigger Sensor für Scatt** **Trigger-sensor for Scatt** 17.113 315,-



**Installation und Einweisung für Scatt (pro Stunde)**  
*Installation and Instruction for Scatt (per hour)*

Preis nach Aufwand

17.119

Price actual costs





Schiesshandschuh ,**Truttmann TR'**, Finger lang  
*Shooting glove ,Truttmann TR'* , long fingers



Schiesshandschuh ,**Truttmann TR'**, Finger kurz  
*Shooting glove ,Truttmann TR'* , short fingers



13.310.S	88,-
13.310.M	88,-
13.310.L	88,-
13.310.XL	88,-

13.311.S	88,-
13.311.M	88,-
13.311.L	88,-
13.311.XL	88,-

Schiesshandschuh ,**Gehmann'**, Finger kurz  
*Shooting glove ,Gehmann'* , short fingers



13.320.XS	74,-
13.320.S	74,-
13.320.M	74,-
13.320.L	74,-
13.320.XL	74,-
13.320.XXL	74,-

Schiesshandschuh ,**Thune, solid/grip'**, Finger kurz  
*Shooting glove ,Thune, solid/grip'* , short fingers



13.330.XS	108,-
13.330.S	108,-
13.330.M	108,-
13.330.L	108,-
13.330.XL	108,-
13.330.XXL	108,-

Schiesshandschuh ,**Thune, solid/grip'**, Finger lang  
*Shooting glove ,Thune, solid/grip'* , long fingers



13.331.XS	108,-
13.331.S	108,-
13.331.M	108,-
13.331.L	108,-
13.331.XL	108,-
13.331.XXL	108,-

Abzugshandschuh ,**Truttmann blau'**, für Rechtsschützen  
*Trigger-hand glove ,Truttmann blue'* , für right hand



13.316.XS	39,-
13.316.S	39,-
13.316.M	39,-
13.316.L	39,-
13.316.XL	39,-
13.316.XXL	39,-

Schießschuh ,**Truttmann Athen'**, Größe 38 - 48  
(letzte Ziffer der Bestellnummer)  
*Shooting Shoe ,Truttmann Athen'* , Size 38 - 48  
(Size is the last number of the order number)



13.341.38	250,-
13.341.39	250,-
13.341.40	250,-
13.341.41	250,-
13.341.42	250,-
13.341.43	250,-
13.341.44	250,-
13.341.45	250,-
13.341.46	250,-
13.341.47	250,-
13.341.48	250,-

Schießschuh ,**Corami'**, Größe 38 - 48  
(letzte Ziffer der Bestellnummer)  
*Shooting Shoe ,Corami'* , Size 38 - 48  
(Size is the last number of the order number)



13.342.38	250,-
13.342.39	250,-
13.342.40	250,-
13.342.41	250,-
13.342.42	250,-
13.342.43	250,-
13.342.44	250,-
13.342.45	250,-
13.342.46	250,-
13.342.47	250,-
13.342.48	250,-

Schießschuhspanner ,**Truttmann'**  
*Shooting Shoe stretchers ,Truttmann'*



13.350	65,-
--------	------

Schieß-Strickjacke ,**Truttmann'**  
*Shooting Sweater ,Truttmann'*



13.111.XS	128,-
13.111.S	128,-
13.111.M	128,-
13.111.L	128,-
13.111.XL	128,-
13.111.XXL	128,-



Air-Jacke ,**Truttmann'**  
*Air-Jaket ,Truttmann'*

13.121.XS	128,-
13.121.S	128,-
13.121.M	128,-
13.121.L	128,-
13.121.XL	128,-
13.121.XXL	128,-





**OLYMPISCHES GEWEHRSCHESSEN**

**Gaby Bühlmann & Heinz Reinkemeier**

Das Standardwerk zum Dreistellungskampf 220 Seiten, gebunden, farbig, mehr als 1500 Abbildungen.

**WAYS OF THE RIFLE**

World's most sold Sportrifle book. Everything to know about 3 positions, many top-shooters all about rifles, technique and tactics.

**LUFTGEWEHR-SCHIESSEN**

Neuaufgabe, 214 Farbseiten, gebunden. 1400 Bilder, viele Top-Schützen in Studioaufnahmen und bei Olympischen Spielen, World-Cups, WM, EM, DM und Bundesliga.

**AIR RIFLE Training & Competition**

The complete manual, 1st English edition. All that you need to know about rifle No. 1, the air rifle. Bound on 214 colour pages, with 1500 photos, drawings and graphics.

**DIE PSYCHE DES SCHUSSES**

**Gaby Bühlmann & Heinz Reinkemeier**

Theorie, Trainingsplan und Übungen. Dieses Buch fasst alles Wissenswerte zum psychologischen Training verständlich zusammen. Pflichtlektüre für alle, die im Wettkampf bestehen wollen.

**SPORT PSYCHOLOGY AND COMPETITION**

This book is a guide to how you can systematically prepare for tour-naments and other stressful moments. It contains 1,000 pictures, 200 exer-cises, a 6-week training plan and audio files on the techniques of psychological regulation.



**LEISTUNGSPLANUNGSGEWehr**

2. Auflage, 128 S., farbig, Spiralbindung. Formulare LG+KK. Alles für Planung und Protokoll im praktischen Ringbuch.

**Mario Gonsierowski**

Neue Trainingshilfen für das Gewehrschießen

10.460 49,-



10.411 66,-



10.410 66,-



10.311 66,-



10.310 66,-



10.431 66,-



10.430 66,-



10.450 17,-

1(1)	3639	CAMPRIANI Niccolo	Bleiker/FWB
2(2)	2828	KAMENSKIY Sergey	Bleiker
3(4)	1841	RAYNAUD Alexis	Bleiker
4(3)	1743	EMMONS Matthew	Bleiker
5(5)	1601	GORSA Petar	Grunig & Elmiger
6(6)	1390	ZHU Qinan	Bleiker/Anshutz
7(7)	1338	BRODMEIER Daniel	Bleiker/MEC
8(8)	1107	LINK Andre	Bleiker
9(9)	1018	HUI Zicheng	Bleiker/Anshutz
10(10)	1000	SEBIC Milenko	Walther
11(11)	933	KULISH Serhiy	Walther
12(12)	868	TSARKOV Oleh	Bleiker
13(13)	781	VLASOV Fedor	Bleiker/Grunig
14(14)	711	BRYHN Ole Kristian	Bleiker
15(15)	608	RAJPUT Sanjeev	Bleiker/Grunig
16(16)	598	RUMPLER Gernot	Walther
17(17)	586	SIDI Peter	Walther
18(18)	531	BREKNE Odd Arne	Bleiker/GE
19(19)	521	PENI Istvan	Walther
20(20)	456	KIM Hyeonjun	Bleiker
21(21)	373	DE NICOLO Marco	Bleiker/GE
22(22)	372	KIM Jonghyun	Bleiker
23(23)	343	SHCHERBATSEVICH Yury	Walther
24(24)	330	SAUVEPLANE Valerian	Bleiker/GE
25(25)	297	LI Jiahong	Bleiker

**ISSF 3 x 40 Weltrangliste 1.1.2017**  
**ISSF 3 x 40 worldranking 1.1.2017**



**FANARTIKEL**  
**Fanmerchandise**

BLEIKER Aufnäher 4 x 11,5 cm	12.260.1	10,-
BLEIKER Patch 4 x 11,5 cm	12.260.2	10,-
BLEIKER-INFO USB-Stick 4GB	12.270	20,-
BLEIKER Aufkleber Sticker 4 x 12 cm	12.280.2	10,-
BLEIKER Aufkleber Sticker 6 x 40 cm	12.280.2	10,-
BLEIKER Poster, 80 x 60 cm	12.290.1	25,-
BLEIKER Poster, englisch, 80 x 60 cm	12.290.2	25,-